

+48 734 481 529 filip@kosbel.pl

Infolinia czynna: pon. - pt. 8:00 - 14:00

+48 608 567 678 ewa@kosbel.pl

Infolinia czynna: pon. - pt. 12:00 - 18:00



Monaco



Fronty wykonane z solidnej płyty MDF o grubości **19 mm**.



Nóżki regulowane (10 cm) umożliwiają precyzyjne ustawienie szafki nawet na nierównym podłożu.

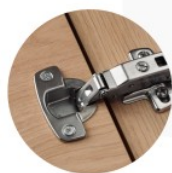

Zawiasy HETTICH
Solidne i wytrzymałe zawiasy wyposażone w ciche domykanie.

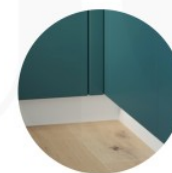

Cokół (10 cm) docięty do szerokości szafki dołączony jest do każdej paczki.

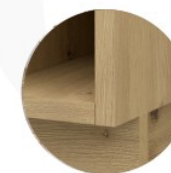

Korpusy wykonane z płyty meblowej o grubości **18 mm**.

- **Strona zewnętrzna** frontów pokryta jest w całości, bez łączeń. Pokrycie obejmuje również **krawędzie** frontów. **Strona wewnętrzna** ma kolor biały.
- Dostępna opcja **LONG**, czyli możliwość wykonania dłuższego od korpusu frontu a dolna „wystająca” część tworzy uchwyt (o cenę pytaj handlowca)

DOSTĘPNE KOLORY KORPUSÓW

Korpusy wykonane są z płyty meblowej, laminowanej o grubości **18 mm**.



LAVA



GREY



BIAŁY



DĄB ARTISAN



Wysokiej jakości zawias Hettich z cichym domykaniem* w standardzie.



Wysokość szafek wiszących
360 / 720 / 960 mm

Głębokość* szafek wiszących
325 mm

Wysokość szafek stojących
z nóżkami i cokołem
820 / 154 / 2070 mm

Głębokość* szafek stojących
500 mm

Głębokość* słupków wysokich
565 mm

DOSTĘPNE KOLORY FRONTÓW LAKIEROWANYCH

N0100	N0101	N0102	N0103	N0104	N0105	N0106	N0107	N0108	N0109	N0110	N0111	N0112
N0113	N0114	N0115	N0116	N0117	N0118	N0119	N0120	N0121	N0122	N0123	N0124	N0125
N0126	N0127	N0128	N0129	N0130	N0131	N0132	N0133	N0134	N0135	N0136	N0137	N0138
N0139	N0140	N0141	N0142	N0143	N0144	N0145	N0146	N0147	N0148	N0149	N0150	N0151
N0152	N0153	N0154	N0155	N0156	N0157	N0158	N0159	N0160	N0161	N0162	N0163	N0164
N0165	N0166	N0167	N0168	N0169	N0170	N0171	N0172	N0173	N0174	N0175	N0176	N0177
N0178	N0179	N0180	N0181	N0182	N0183	N0184	N0185	N0186	N0187	N0188	N0189	N0190
N0191	N0192	N0193	N0194	N0195	N0196	N0197	N0198	N0199	N0200	N0201	N0202	N0203
N0204	N0205	N0206	N0207	N0208	N0209	N0210	N0211	N0212	N0213	N0214	N0215	N0216
N0217	N0218	N0219	N0220	N0221	N0222	N0223	N0224	N0225	N0226	N0227	N0228	N0229
N0230	N0231	N0232	N0233	N0234	N0235	N0236	N0237	N0238	N0239	N0240	N0241	N0242
N0243	N0244	N0245	N0246	N0247	N0248	N0249	N0250	N0251	N0252	N0253	N0254	N0255
N0256	N0257	N0258	N0259									



Ważne! Prosimy pamiętać, że to samo zdjęcie na każdym monitorze będzie wyświetlone w innej kolorystyce. Zdjęcia zostały wykonane w określonych warunkach oświetleniowych, które mają istotny wpływ na wygląd prezentowanych produktów. Produkty bowiem częściowo absorbują, a częściowo odbijają światło i jego barwę. A zatem percepcja zakupionych produktów, może być inna niż percepcja zamieszczonych zdjęć, nawet na skalibrowanych monitorach, gdyż niemożliwe może być odtworzenie identycznych warunków zewnętrznych. **Aby dobrać najbardziej odpowiedni kolor frontu/ów dla siebie proszę o porównanie ich fizycznie z paletą RAL lub ICA.**

1000	1018	2003	3011	4009	5014	6005	6020	7003	7024	7044	8016	9016
1001	1019	2004	3012	4010	5015	6006	6021	7004	7026	7045	8017	9017
1002	1020	2008	3013	5000	5017	6007	6022	7005	7030	7046	8019	9018
1003	1021	2009	3014	5001	5018	6008	6024	7006	7031	7047	8022	
1004	1023	2010	3015	5002	5019	6009	6025	7008	7032	8000	8023	
1005	1024	2011	3016	5003	5020	6010	6026	7009	7033	8001	8024	
1006	1027	2012	3017	5004	5021	6011	6027	7010	7034	8002	8025	
1007	1028	3000	3018	5005	5022	6012	6028	7011	7035	8003	8028	
1011	1032	3001	3020	5007	5023	6013	6029	7012	7036	8004	9001	
1012	1033	3002	3022	5008	5024	6014	6032	7013	7037	8007	9002	
1013	1034	3003	3027	5009	6000	6015	6033	7015	7038	8008	9003	
1014	1037	3004	3031	5010	6001	6016	6034	7016	7039	8011	9004	
1015	2000	3005	4001	5011	6002	6017	7000	7021	7040	8012	9005	
1016	2001	3007	4002	5012	6003	6018	7001	7022	7042	8014	9010	
1017	2002	3009	4003	5013	6004	6019	7002	7023	7043	8015	9011	



Ważne! Prosimy pamiętać, że to samo zdjęcie na każdym monitorze będzie wyświetlone w innej kolorystyce. Zdjęcia zostały wykonane w określonych warunkach oświetleniowych, które mają istotny wpływ na wygląd prezentowanych produktów. Produkty bowiem częściowo absorbują, a częściowo odbijają światło i jego barwę. A zatem percepcja zakupionych produktów, może być inna niż percepcja zamieszczonych zdjęć, nawet na skalibrowanych monitorach, gdyż niemożliwe może być odtworzenie identycznych warunków zewnętrznych. **Aby dobrać najbardziej odpowiedni kolor frontu/ów dla siebie proszę o porównanie ich fizycznie z paletą RAL lub ICA.**

SZAFKI WISZĄCE / 72 CM



Solidne i wytrzymałe, zawiasy **HETTICH** z cichym zamykaniem.



Zawieszki regulowane, umożliwiają łatwe i precyzyjne zawieszenie szafek.



Zalecamy stosowanie listw montażowych.

(szer./wys./gł.)

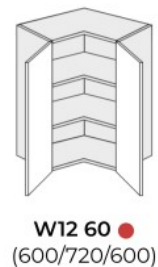
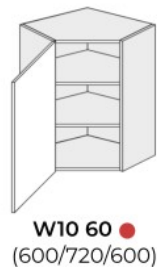
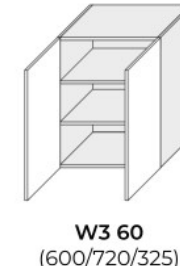
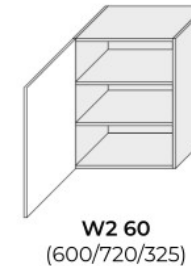
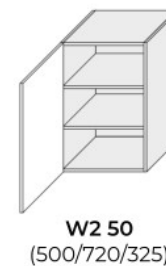
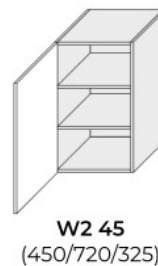
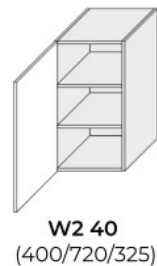
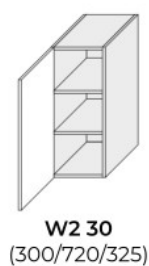
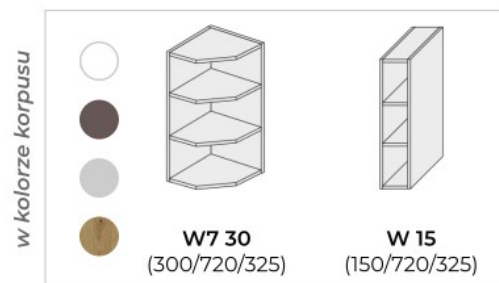

do wyboru
szyba mleczna, lub przezroczysta

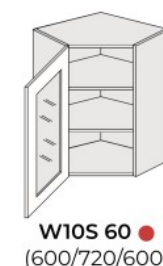
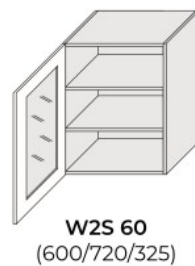
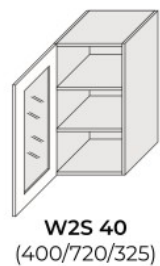

● - brak cichego domknięcia* w standardzie.
Opcja dodatkowo płatna.

NOWOŚĆ! Fronty long, czyli możliwość wykonania dłuższego od korpusu frontu a dolna „wystająca” część tworzy uchwyt (o cenę pytaj handlowca)

SZAFKI WISZĄCE / 36 CM

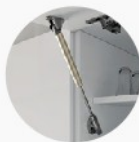

Zastosowanie **teleskopów gazowych** w szafkach otwieranych do góry.



Zawieszki regulowane, umożliwiają łatwe i precyzyjne zawieszenie szafek.

(szer./wys./gł.)



W4B 30
(300/360/325)

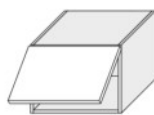

W4B 50
(500/360/325)



W4B 60
(600/360/325)

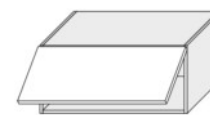

W4B 80
(800/360/325)

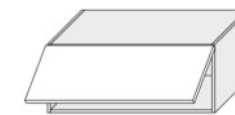

W4B 90
(900/360/325)



W4BS 60 WKF*
(600/360/325)



W4BS 80 WKF*
(800/360/325)



W4BS 90 WKF*
(900/360/325)

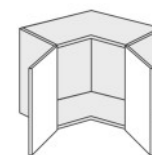

W12/60 ●
(600/360/600)

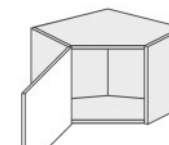

W10/60 ●
(600/360/600)

NADSTAWKI



W6B 40
(400/360/565)
nadstawka



W6B 60
(600/360/565)
nadstawka

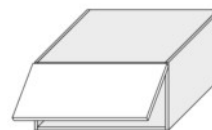

W6B 80
(800/360/565)
nadstawka

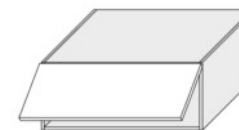

W6B 90
(900/360/565)
nadstawka



W14 90 ●
(900/360/900)
nadstawka narożna

● - brak cichego domykania* w standardzie.
Opcja dodatkowo płatna.

NOWOŚĆ! Fronty long, czyli możliwość wykonania dłuższego od korpusu frontu a dolna „wystająca” część tworzy uchwyt (o cenę pytaj handlowca)

SZAFKI WISZĄCE / 96 CM



Solidne i wytrzymałe, zawiasy **HETTICH** z cichym zamykaniem.



Zawieszki regulowane, umożliwiają łatwe i precyzyjne zawieszenie szafek.



Zalecamy stosowanie listw montażowych.

(szer./wys./gł.)

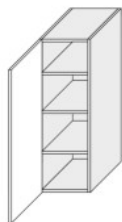

W4 30
(300/960/325)



W4 40
(400/960/325)



W4 45
(450/960/325)

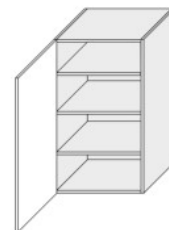

W4 50
(500/960/325)

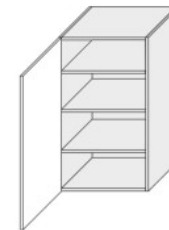

W4 60
(600/960/325)



W4 60 2F
(600/960/325)

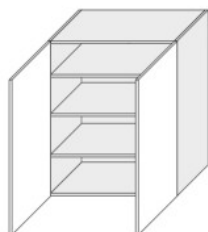

W4 80
(800/960/325)

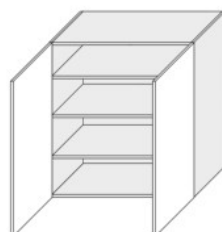

W4 90
(900/960/325)



W4 10/60 ●
(600/960/600)



W4S 40
(400/960/325)

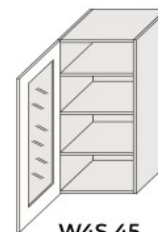

W4S 45
(450/960/325)



W4S 50
(500/960/325)

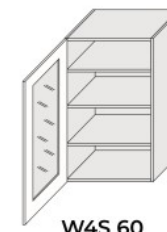

W4S 60
(600/960/325)

do wyboru
szyba mleczna, lub przezroczysta

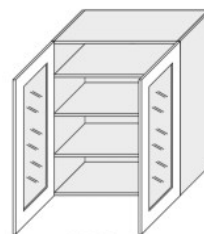

W4S 80
(800/960/325)

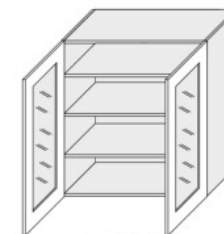

W4S 90
(900/960/325)

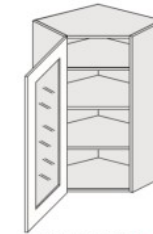

W4S 10/60 ●
(600/960/600)

● - brak cichego domykania* w standardzie.
Opcja dodatkowo płatna.

NOWOŚĆ! Fronty long, czyli możliwość wykonania dłuższego od korpusu frontu a dolna „wystająca” część tworzy uchwyt (o cenę pytaj handlowca)



System **AVENTOS** oraz **AVENTOS HK** firmy **BLUM**.
Komfort ruchu oraz swoboda
użytkowania każdego dnia.

(szer./wys./gł.)

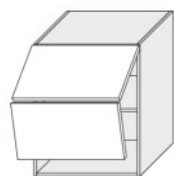

W8B 60 AVENTOS
(600/720/325)

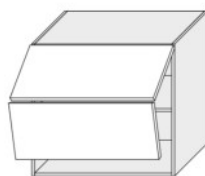

W8B 80 AVENTOS
(800/720/325)

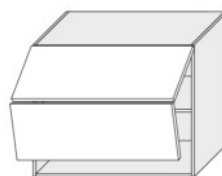

W8B 90 AVENTOS
(900/720/325)

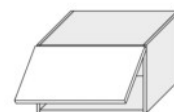

W4B 60 AVENTOS HK
(600/360/325)



W4B 80 AVENTOS HK
(800/360/325)



W4B 90 AVENTOS HK
(900/360/325)



W8BS 60 AV WKF*
(600/720/325)



W8BS 80 AV WKF*
(800/720/325)



W8BS 90 AV WKF*
(900/720/325)

NOWOŚĆ! Fronty long, czyli możliwość wykonania dłuższego od korpusu frontu
a dolna „wystająca” część tworzy uchwyt (o cenę pytaj handlowca)

SZAFKA PRZYGOTOWANA POD OKAP

SZAFKA POD MIKROFAŁĘ

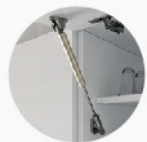

Zastosowanie **teleskopów gazowych** w szafkach otwieranych do góry.

(szer./wys./gł.)



zdjęcie przykładowe

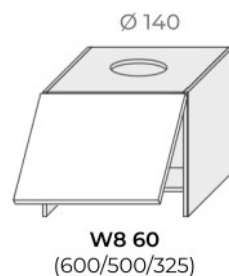

zdjęcie przykładowe



Szafka **PREMIUM** w korpusie **CZARNA PERŁA** z szybą przezroczystą w czarnej ramce aluminiowej.



zdjęcie przykładowe

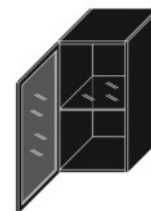

W2S 40 BLACK ALU
(400/720/325)

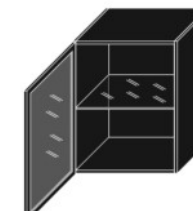

W3S 60 BLACK ALU
(600/720/325)

SZAFKI STOJĄCE



Solidne i wytrzymałe, zawiasy HETTICH z cichym zamykaniem.



Nóżki regulowane, umożliwiające precyzyjne ustawienie szafki nawet na nierównym podłożu.

(szer./wys./gt.)

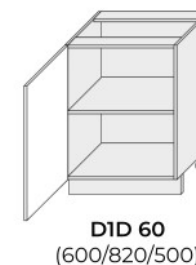
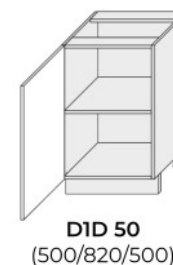
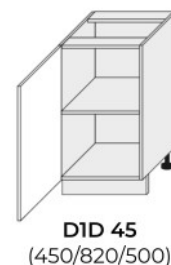
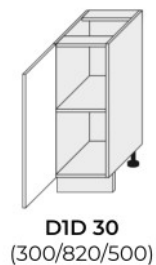

zabudowa piekarnika



pod zlew

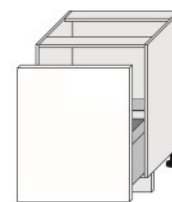
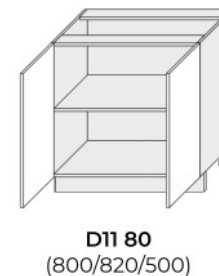
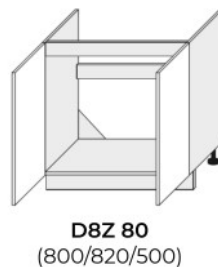

D1D 60 - szuflada SEGREGO
(600/820/500)



KOSZE CARGO

- prowadnica z montażem do dna korpusu • regulacja 3D • szybki montaż – system Click •
- możliwość zamontowania przegród do organizacji wewnętrznej • szablon montażowy w zestawie • dopuszczalne obciążenie 20kg

(szer./wys./gł.)

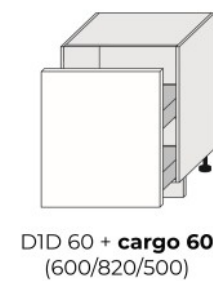
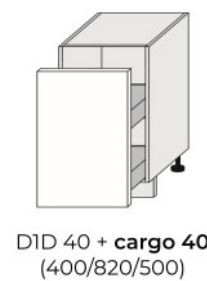
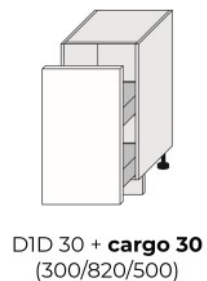

FRONTY ZMYWARKOWE

Zmywarki do zabudowy wymagają jedynie przedniego panelu. Do ich zabudowy nie jest wymagany dodatkowy korpus.

(szer./wys./gł.)

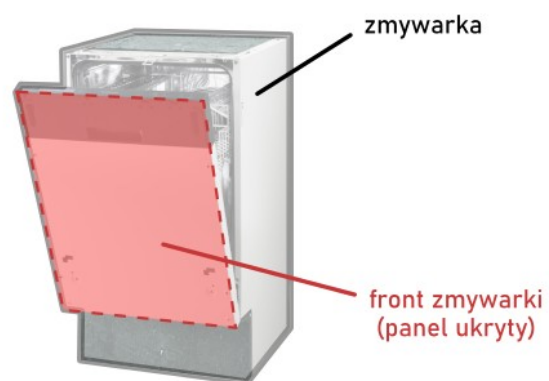

Panel zmywarkowy widoczny

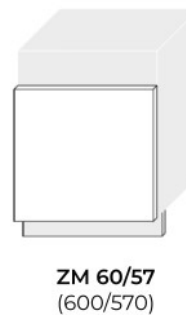
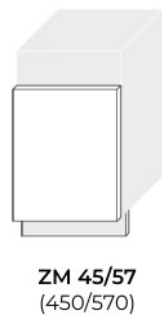

Panel zmywarkowy niewidoczny

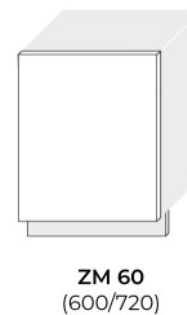
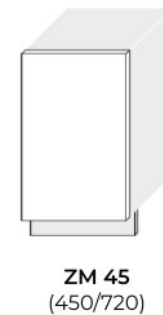



Wysokiej jakości system szuflad **METABOX / BLUM** zapewniają wysoką stabilność, także w przypadkach **maksymalnego obciążenia, które wynosi 30 kg.** Brak cichego domyknięcia w standardzie*.

(szer./wys./gł.)



D2M/120 ●
(1200/460/500)

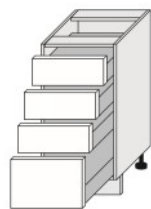

D4M 40 ●
(400/820/500)



D3M 50 ●
(500/820/500)

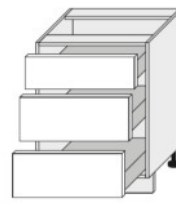

D3M 60 ●
(600/820/500)

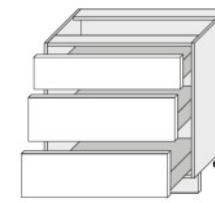

D3M 80 ●
(800/820/500)

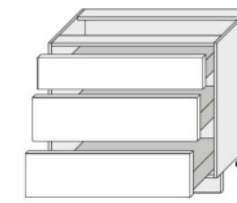

D3M 90 ●
(900/820/500)



Szuflady dostępne w kolorze szarym.

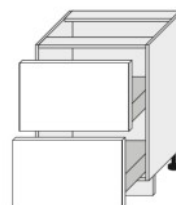

D2M 60 ●
(600/820/500)

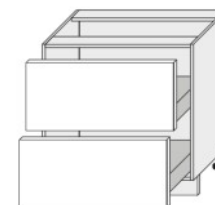

D2M 80 ●
(800/820/500)

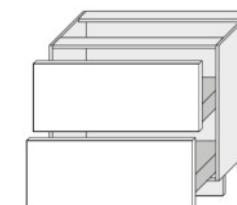

D2M 90 ●
(800/820/500)

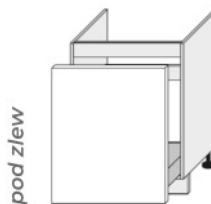

D1ZM 60 ●
(600/820/500)

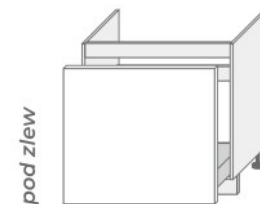

D1ZM 80 ●
(800/820/500)

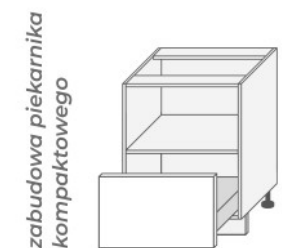

D11K M/60 KOMPAKT ●
(600/820/500)

● - brak cichego domyknięcia* w standardzie. Opcja dodatkowo płatna.

*Do szuflady METABOX z częściowym wysuwem można zastosować sprawdzoną funkcję **BLUMOTION** - jest to dodatkowy hamulec do szuflady, który należy dodatkowo zakupić i zamontować.

Szuflady z serii **COMFORT BOX** to innowacyjne produkty umożliwiające utrzymanie porządku na najwyższym poziomie. **Ładowność do 35kg. Pełny wysuw, prowadnica z miękkim dociąganiem.**



(szer./wys./gł.)

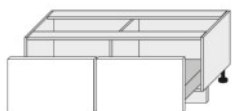

D2R/120
(1200/460/500)

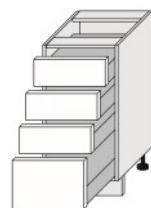

D4R 40
(400/820/500)

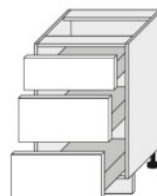

D3R 50
(500/820/500)

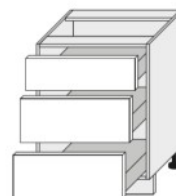

D3R 60
(600/820/500)

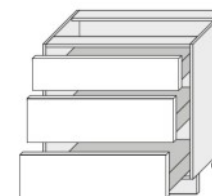

D3R 80
(800/820/500)

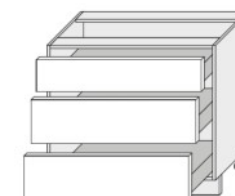

D3R 90
(900/820/500)

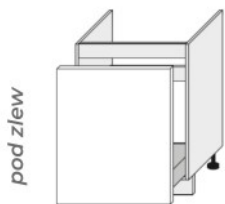

D1ZR 60
(600/820/500)

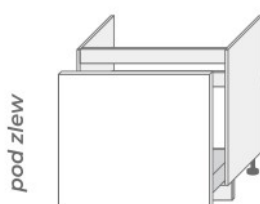

D1ZR 80
(800/820/500)

zabudowa piekarnika
kompaktowego

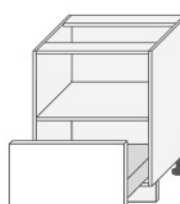

D11K R/60 KOMPAKT
(600/820/500)

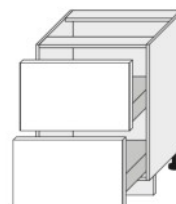

D2R 60
(600/820/500)

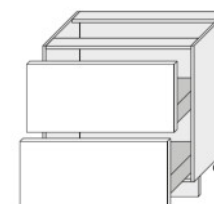

D2R 80
(800/820/500)

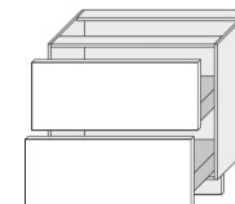

D2R 90
(900/820/500)

PROWADNICE W KOLORZE BIAŁYM.





Wysokiej jakości system szuflad **InnoTech ATIRA** wyposażonych w pełen wysuw oraz **ciche domykanie**.
maksymalne obciążenie do **30 kilogramów**.

(szer./wys./gł.)



D2A/120
(1200/460/500)



D4A 40
(400/820/500)

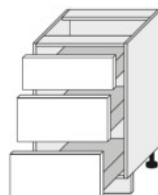

D3A 50
(500/820/500)

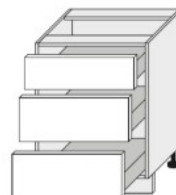

D3A 60
(600/820/500)

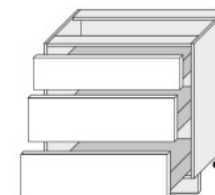

D3A 80
(800/820/500)

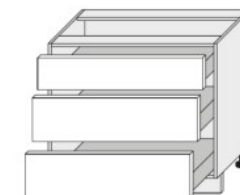

D3A 90
(900/820/500)

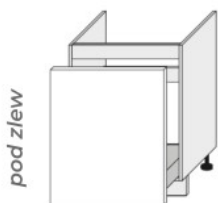

D1ZA 60
(600/820/500)

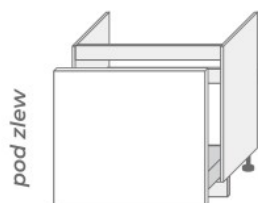

D1ZA 80
(800/820/500)

*zabudowa piekarnika
kompaktowego*

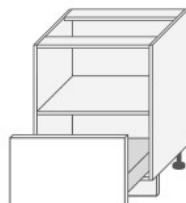

D11K A/60 KOMPAKT
(600/820/500)

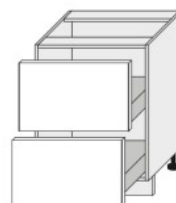

D2A 60
(600/820/500)

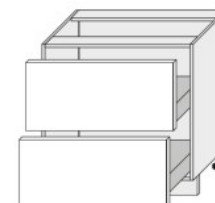

D2A 80
(800/820/500)

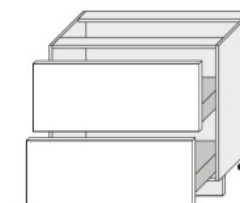

D2A 90
(900/820/500)



PROWDANICE W KOLORZE CZARNYM.

z szufladą wewnętrzną

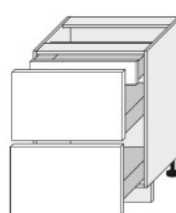

D2A/60/1A
(600/820/500)

z szufladą wewnętrzną

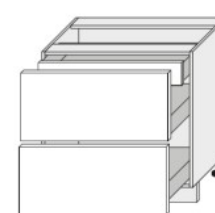

D2A/80/1A
(800/820/500)

z szufladą wewnętrzną

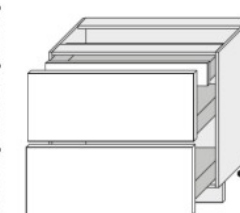

D2A/90/1A
(900/820/500)

SZAFKI STOJĄCE, NAROŻNE

(szer./wys./gł.)

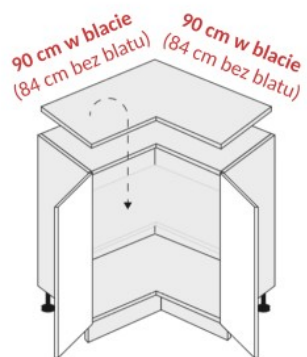

D12 90 bez półki
(840/820/840)

półka dla D12 90



kosz obrotowy

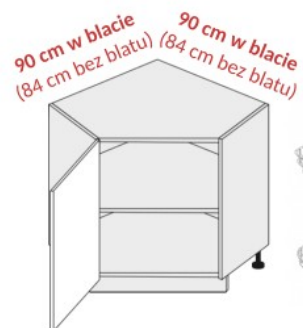

D12R 90
(840/820/840)



kosz obrotowy

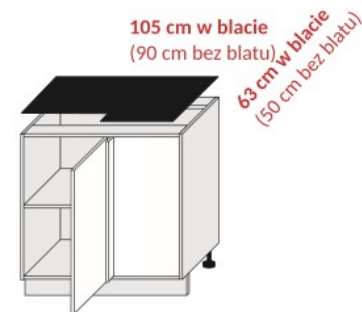

D13U 90 L/P
(900/820/500)

● - brak cichego domykania* w standardzie. Opcja dodatkowo płatna.

SŁUPKI 154 CM

(szer./wys./gł.)



pod piekarnik i mikrofalę

D5AM 60 / 154 ●
(600/1540/565)



pod piekarnik i mikrofalę

D5AR 60 / 154
(600/1540/565)



pod piekarnik i mikrofalę

D5AA 60 / 154
(600/1540/565)

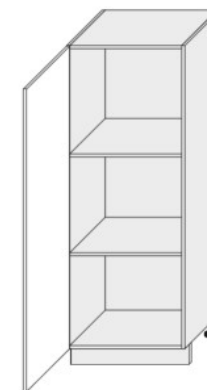

D5D 60 / 154
(600/1540/565)



KOSZ MIDI
dla D5D 60

SŁUPKI 207 CM

(szer./wys./gł.)

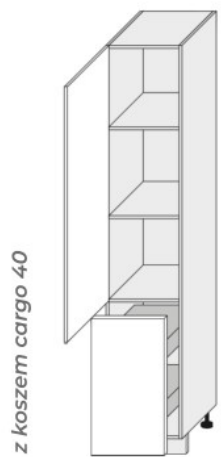

z koszem cargo 40

2D14K 40
(400/2070/565)

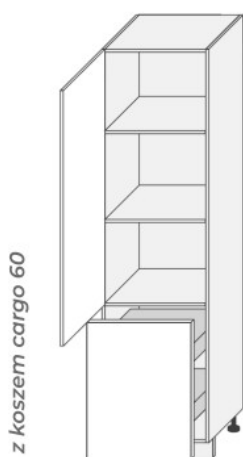

z koszem cargo 60

D14DP 60
(600/2070/565)

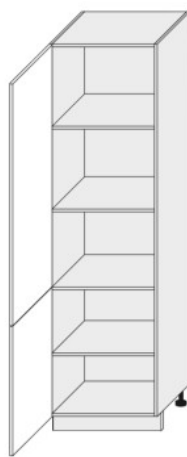

D14 DP 60
(600/2070/565)

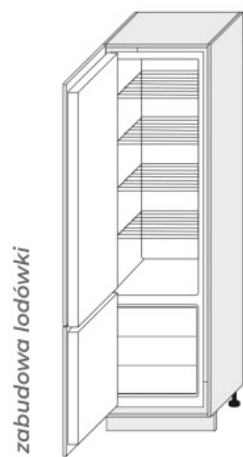

zabudowa lodówki

D14 DL 60
(600/2070/565)

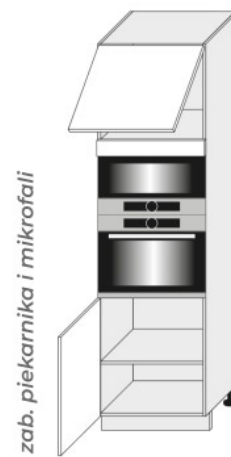

zab. piekarnika i mikrofalni

D14 RU 60
(600/2070/565)



zab. piekarnika

D14 RU 2D 60
(600/2070/565)

blum

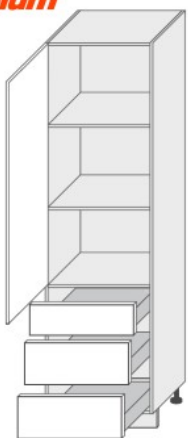

D/14/DP/3M ●
(600/2070/565)

REJS

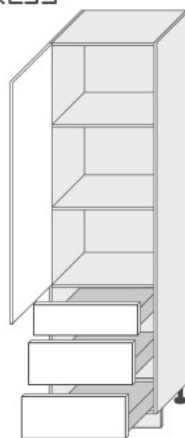

D/14/DP/3R
(600/2070/565)

Hettich

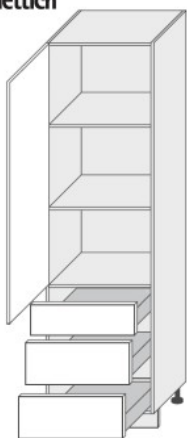

D/14/DP/3A
(600/2070/565)





D14 RU 2M KOMPAKT ●
(600/2070/565)

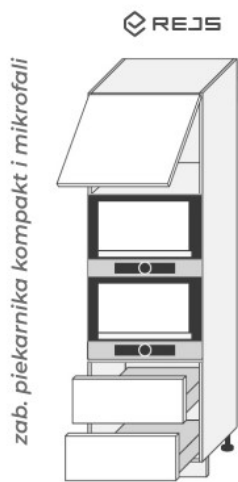

D14 RU 2R KOMPAKT
(600/2070/565)

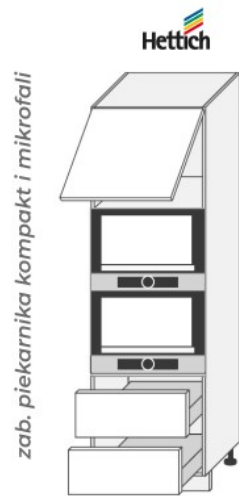

D14 RU 2A KOMPAKT
(600/2070/565)



D14 RU 3A 60
(600/2070/565)

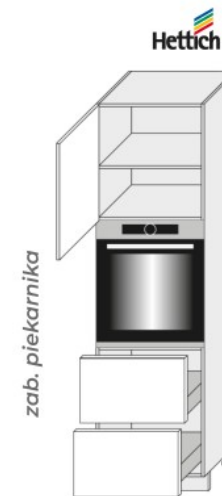

D14 RU 2A 60 356
(600/2070/565)



D14 RU 2A 60 284
(600/2070/565)

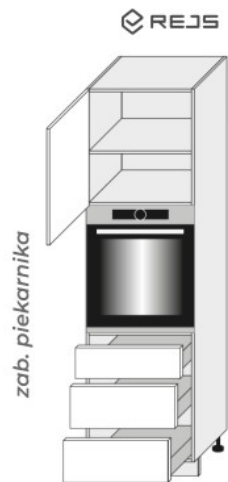

D14 RU 3R 60
(600/2070/565)

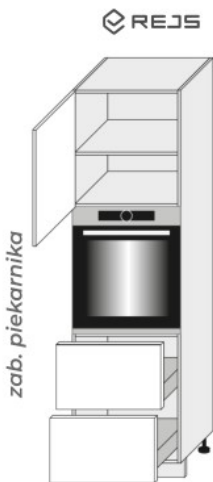

D14 RU 2R 60 356
(600/2070/565)

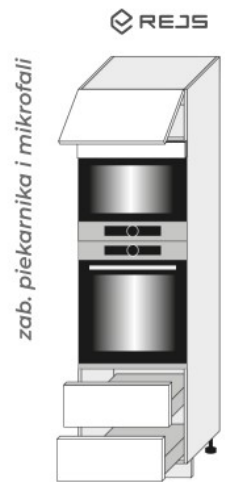

D14 RU 2R 60 284
(600/2070/565)

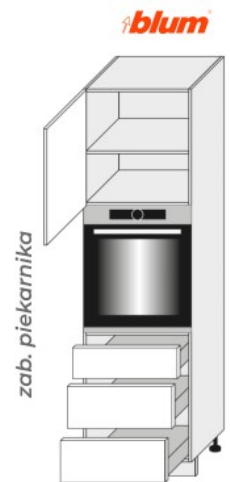

D14 RU 3M 60 ●
(600/2070/565)

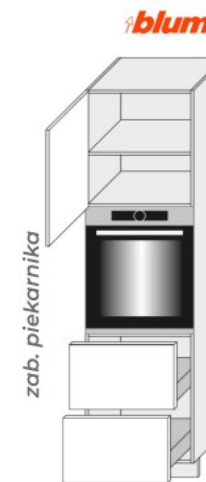

D14 RU 2M 60 356 ●
(600/2070/565)



D14 RU 2M 60 284 ●
(600/2070/565)

Szafki dostępne wyłącznie w korpusie **DĄB ARTISAN**

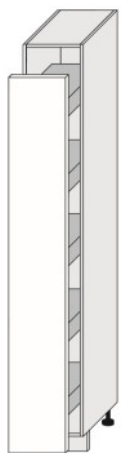

1D14K / 20 / CARGO
(200/2070/565)

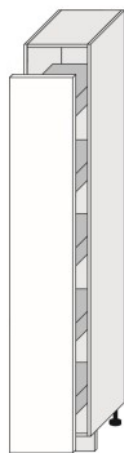

1D14K / 30 / CARGO
(600/2070/565)

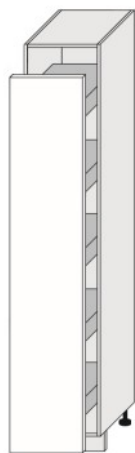

1D14K / 40 / CARGO
(600/2070/565)

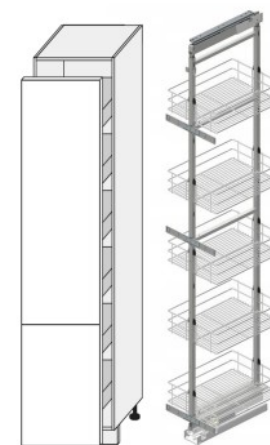

2D14K 40 + kosz MAXI 40
(400/2070/565)



Meble Kosbel

www.kosbel.pl



[kosbel.pl](https://www.instagram.com/kosbel.pl)

WYMIARY AGD DO NASZYCH SZAFEK

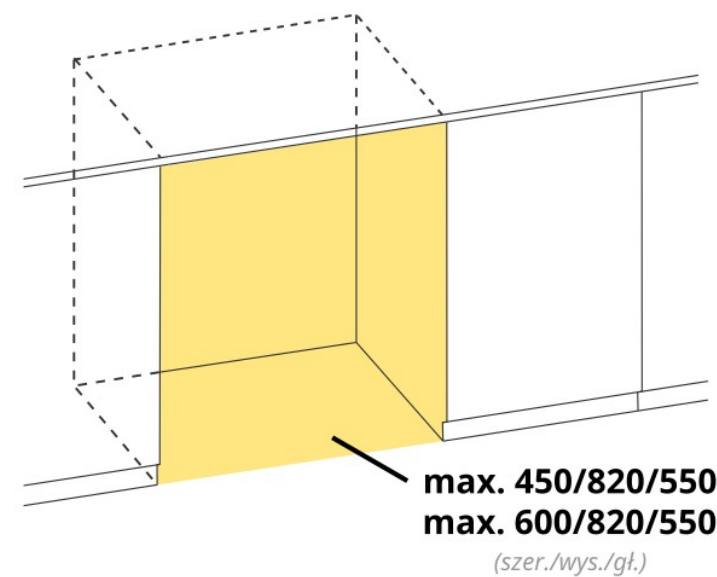
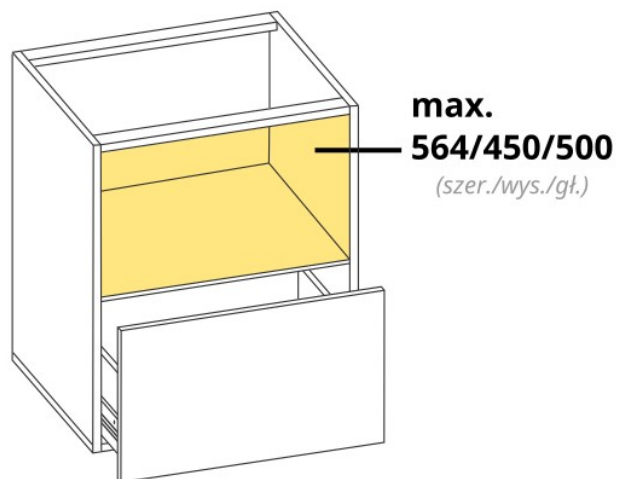
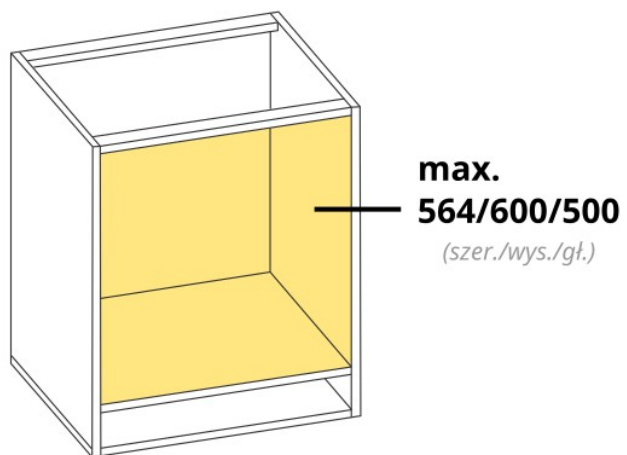
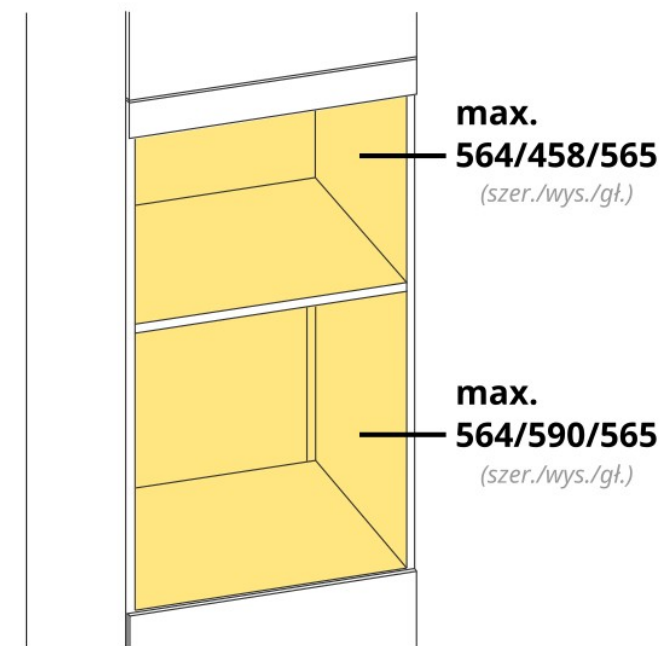
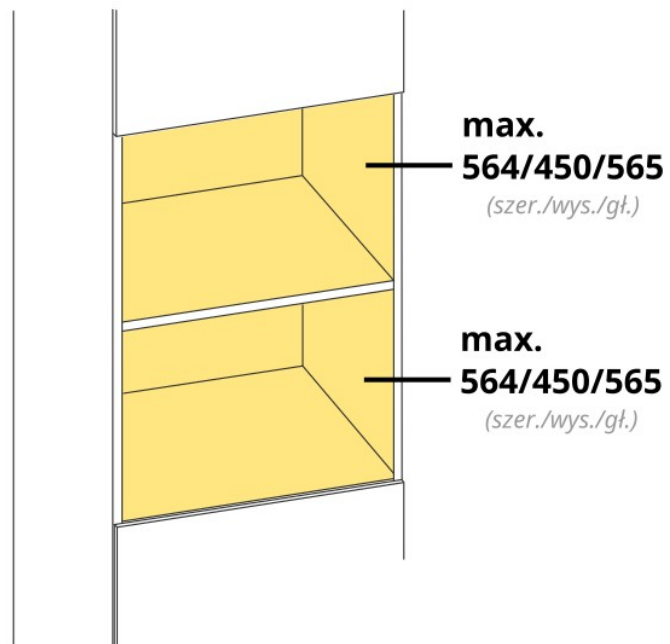
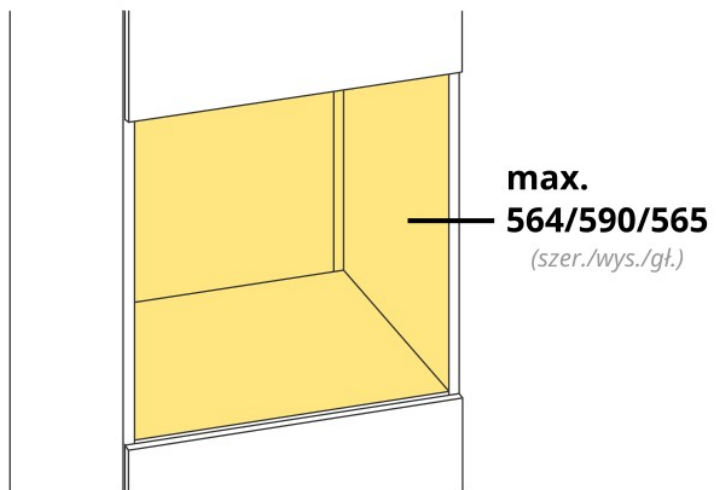

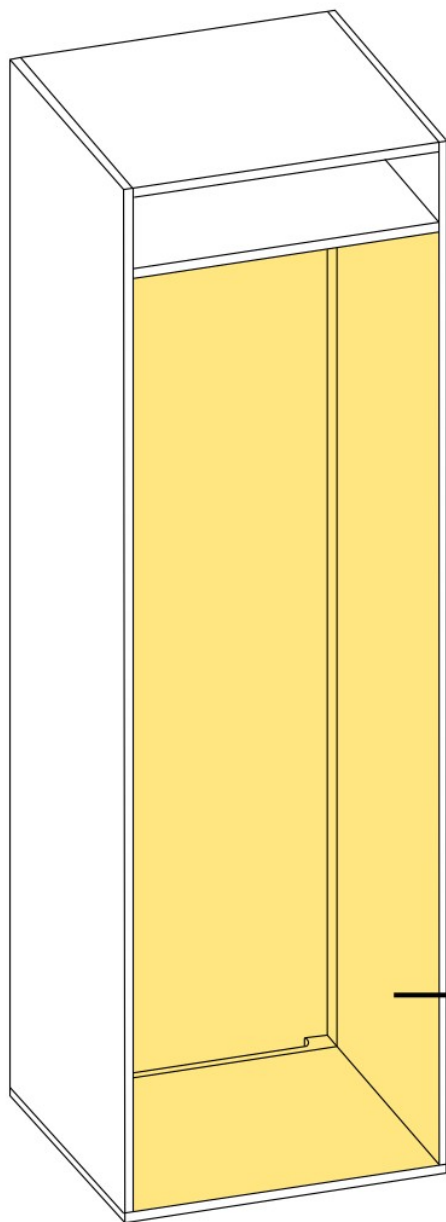

max.
1780/564/565
(szer./wys./gł.)

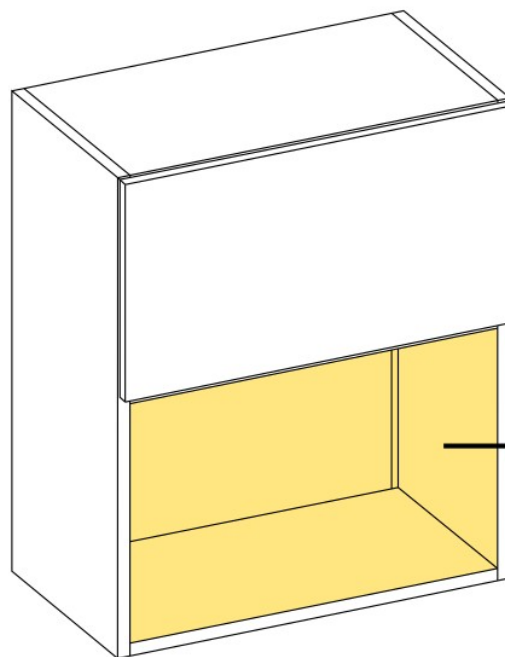

max.
564/360/305-325*
(szer./wys./gł.)

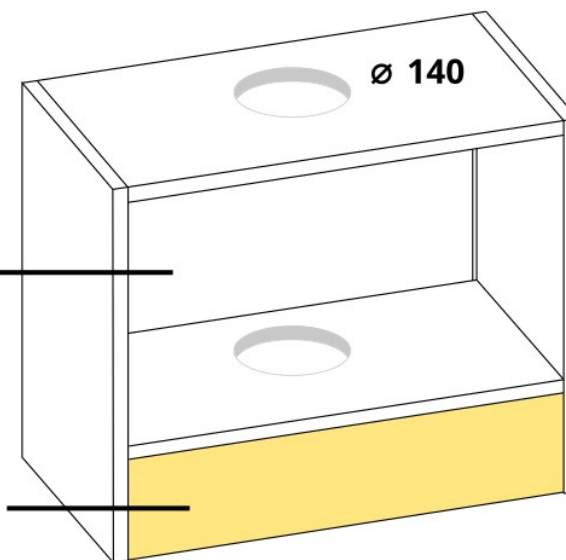

max.
564/329/305
(szer./wys./gł.)

max.
564/135/305
(szer./wys./gł.)

W NASZEJ OFERCIE ZNAJDZIESZ RÓWNIEŻ



blaty laminowane na wymiar
według potrzeb klienta



uchwyty standardowe, gałki,
uchwyty krawędziowe



pojemniki na odpady,
szuflady z pojemnikami
na odpady



oświetlenie podszawkowe,
szafkowe oraz cokołów



możliwość zakupu
pojedynczych frontów
lub korpusów



kosze cargo, nóżki cokołowe,
listwy, spawalnicze, stelaże
metalowe i wiele więcej...

O SZCZEGÓŁY PYTAJ HANDLOWCÓW

ewa@kosbel.pl

filip@kosbel.pl

Katalog nie stanowi oferty w rozumieniu prawa i jest publikowany jedynie dla celów informacyjnych. Prowadząc politykę ciągłego rozwoju zastrzegamy sobie prawo do zmian i ulepszeń produktów przedstawionych w katalogu bez uprzedniego powiadomienia. Kolorystyka przedstawiona w katalogu może się różnić od rzeczywistej. Zastrzegamy sobie prawo do błędów w druku.