

**+48 734 481 529** [filip@kosbel.pl](mailto:filip@kosbel.pl)

*Infolinia czynna: pon. - pt. 8:00 - 14:00*

**+48 608 567 678** [ewa@kosbel.pl](mailto:ewa@kosbel.pl)

*Infolinia czynna: pon. - pt. 12:00 - 18:00*



# Eden

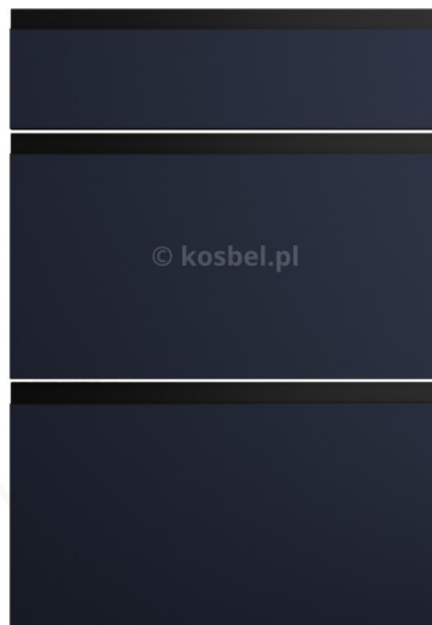
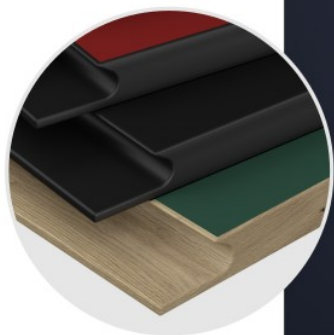

EMERALD



ROYAL GOLD



NAVY



CRIMSON



CZARNY

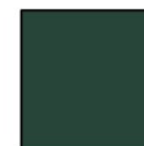

EMERALD



**Fronty** wykonane z solidnej płyty MDF o grubości **18 mm**.



**Nóżki regulowane** (10 cm) umożliwiają precyzyjne ustawienie szafki nawet na nierównym podłożu.

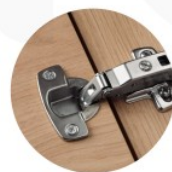

**Zawiasy HETTICH**  
Solidne i wytrzymałe zawiasy wyposażone w ciche domykanie.

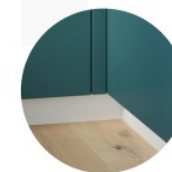

**Cokół (10 cm)** docięty do szerokości szafki dołączony jest do każdej paczki.



**Korpusy** wykonane z płyty meblowej o grubości **18 mm**.

# DOSTĘPNE KOLORY KORPUSÓW

Korpusy wykonane są z płyty meblowej, laminowanej o grubości **18 mm**.



LAVA



GREY



BIAŁY



DĄB ARTISAN



Wysokiej jakości zawias Hettich z cichym domykaniem\* w standardzie.



Wysokość szafek wiszących  
**360 / 720 / 960 mm**

Głębokość\* szafek wiszących  
**325 mm**

Wysokość szafek stojących  
z nóżkami i cokołem  
**820 / 154 / 2070 mm**

Głębokość\* szafek stojących  
**500 mm**

Głębokość\* słupków wysokich  
**565 mm**

# SZAFKI WISZĄCE / 72 CM



Solidne i wytrzymałe, zawiasy **HETTICH** z cichym zamykaniem.



Zawieszki regulowane, umożliwiają łatwe i precyzyjne zawieszenie szafek.



Zalecamy stosowanie listw montażowych.

(szer./wys./gł.)

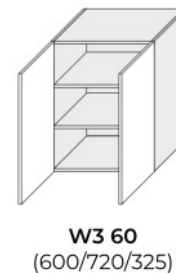
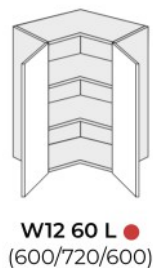
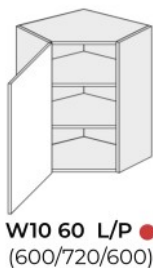
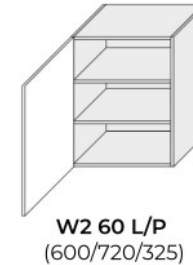
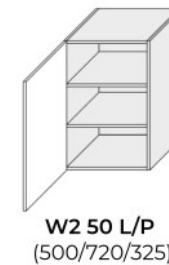
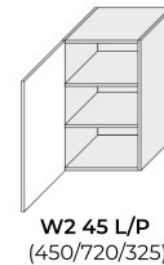
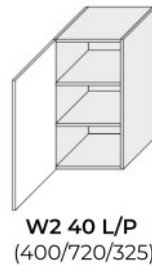
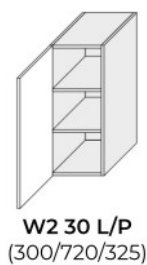
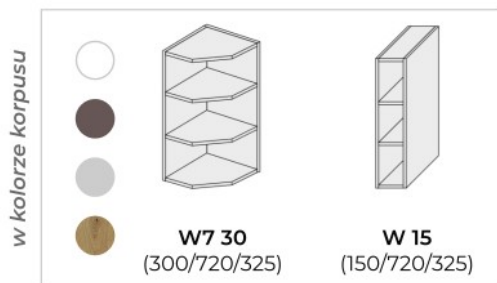

● - brak cichego domykania\* w standardzie.  
Opcja dodatkowo płatna.

## SZAFKI WISZĄCE / 36 CM

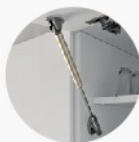

Zastosowanie **teleskopów gazowych** w szafkach otwieranych do góry.



**Zawieszki regulowane**, umożliwiają łatwe i precyzyjne zawieszenie szafek.

(szer./wys./gł.)



**W4B 30**  
(300/360/325)

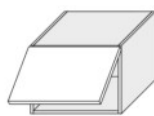

**W4B 50**  
(500/360/325)

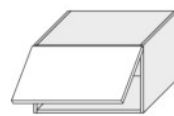

**W4B 60**  
(600/360/325)

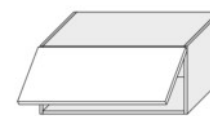

**W4B 80**  
(800/360/325)

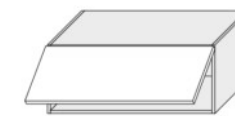

**W4B 90**  
(900/360/325)



**W4BS 60 LAM\***  
(600/360/325)



**W4BS 80 LAM\***  
(800/360/325)

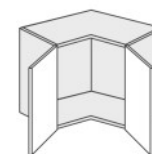

**W12/60** ●  
(600/360/600)

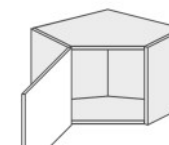

**W10/60** ●  
(600/360/600)

## NADSTAWKI

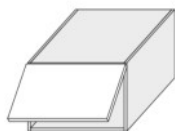

**W6B 40**  
(400/360/565)  
nadstawka

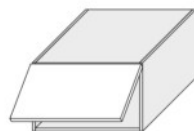

**W6B 60**  
(600/360/565)  
nadstawka

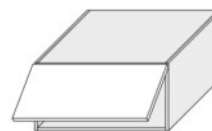

**W6B 80**  
(800/360/565)  
nadstawka

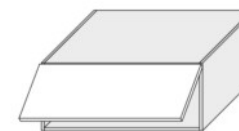

**W6B 90**  
(900/360/565)  
nadstawka



**W14 90** ●  
(900/360/900)  
nadstawka narożna

● - brak cichego domykania\* w standardzie.  
Opcja dodatkowo płatna.

# SZAFKI WISZĄCE / 96 CM



Solidne i wytrzymałe, zawiasy **HETTICH** z cichym zamykaniem.



Zawieszki regulowane, umożliwiają łatwe i precyzyjne zawieszenie szafek.



Zalecamy stosowanie listw montażowych.

(szer./wys./gł.)

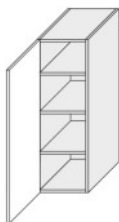

**W4 30 L/P**  
(300/960/325)



**W4 40 L/P**  
(400/960/325)

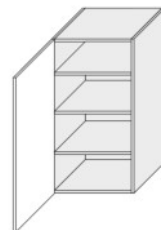

**W4 45 L/P**  
(450/960/325)

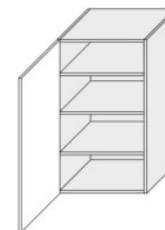

**W4 50 L/P**  
(500/960/325)

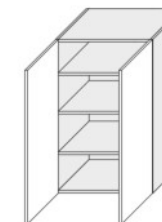

**W4 60 2F**  
(600/960/325)

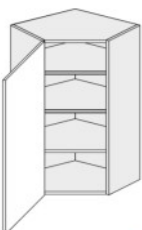

**W4 10/60 L** ●  
(600/960/600)

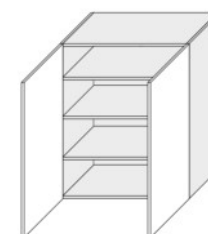

**W4 80**  
(800/960/325)

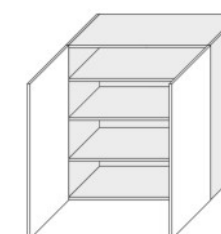

**W4 90**  
(900/960/325)

● - brak cichego domykania\* w standardzie.  
Opcja dodatkowo płatna.



System **AVENTOS** oraz **AVENTOS HK** firmy **BLUM**.  
Komfort ruchu oraz swoboda  
użytkowania każdego dnia.

(szer./wys./gł.)

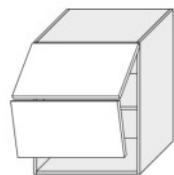

**W8B 60 AVENTOS**  
(600/720/325)

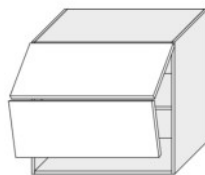

**W8B 80 AVENTOS**  
(800/720/325)

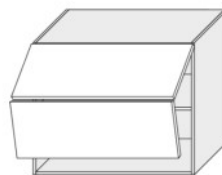

**W8B 90 AVENTOS**  
(900/720/325)



**W4B 60 AVENTOS HK**  
(600/360/325)



**W4B 80 AVENTOS HK**  
(800/360/325)



**W4B 90 AVENTOS HK**  
(900/360/325)



**W8BS 60 AV WKF\***  
(600/720/325)



**W8BS 80 AV WKF\***  
(800/720/325)



**W8BS 90 AV WKF\***  
(900/720/325)

## SZAFKA PRZYGOTOWANA POD OKAP

## SZAFKA POD MIKROFAŁĘ

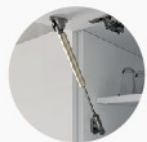

Zastosowanie **teleskopów gazowych** w szafkach otwieranych do góry.

(szer./wys./gł.)



zdjęcie przykładowe

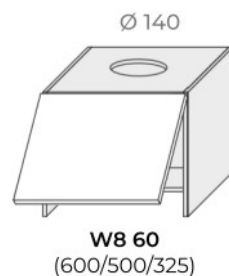

zdjęcie przykładowe



Szafka **PREMIUM** w korpusie **CZARNA PERŁA** z szybą przezroczystą w czarnej ramce aluminiowej.



zdjęcie przykładowe

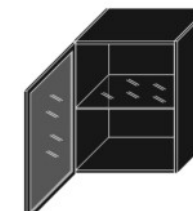
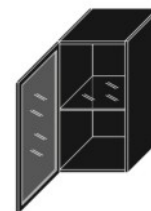



# SZAFKI STOJĄCE



Solidne i wytrzymałe, zawiasy HETTICH z cichym zamykaniem.



Nóżki regulowane, umożliwiające precyzyjne ustawienie szafki nawet na nierównym podłożu.

(szer./wys./gt.)

w kolorze korpusu

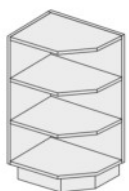

**D6 30**  
(300/820/500)



**D15 O**  
(150/820/500)

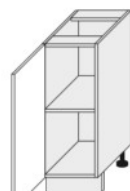

**D1D 30 L/P**  
(300/820/500)

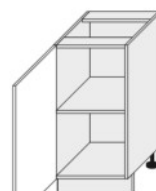

**D1D 40 L/P**  
(400/820/500)

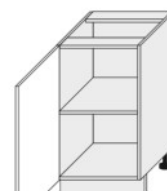

**D1D 45 L/P**  
(450/820/500)

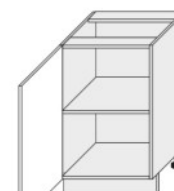

**D1D 50 L/P**  
(500/820/500)

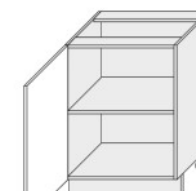

**D1D 60 L/P**  
(600/820/500)

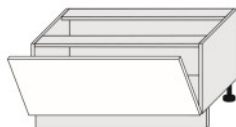

**D1K 90**  
(900/460/500)

zabudowa piekarnika

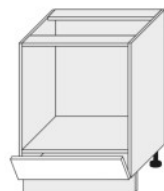

**D11K 60**  
(600/820/500)

pod zlew

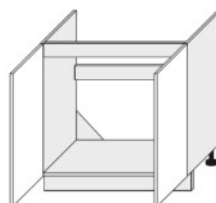

**D8Z 80**  
(800/820/500)

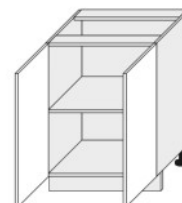

**D11 60**  
(600/820/500)

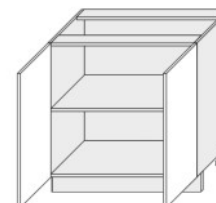

**D11 80**  
(800/820/500)

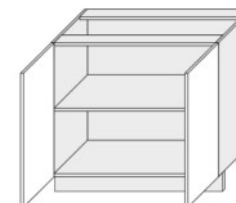

**D11 90**  
(900/820/500)

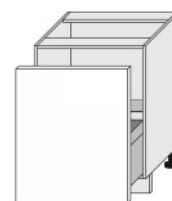

**D1D 60 - szuflada SEGREGO**  
(600/820/500)



## KOSZE CARGO

- prowadnica z montażem do dna korpusu • regulacja 3D • szybki montaż – system Click •
- możliwość zamontowania przegród do organizacji wewnętrznej • szablon montażowy w zestawie • dopuszczalne obciążenie 20kg

(szer./wys./gł.)

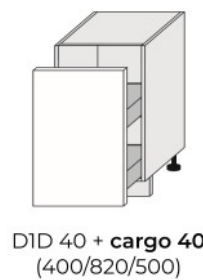

## FRONTY ZMYWARKOWE

Zmywarki do zabudowy wymagają jedynie przedniego panelu. Do ich zabudowy nie jest wymagany dodatkowy korpus.

(szer./wys./gł.)

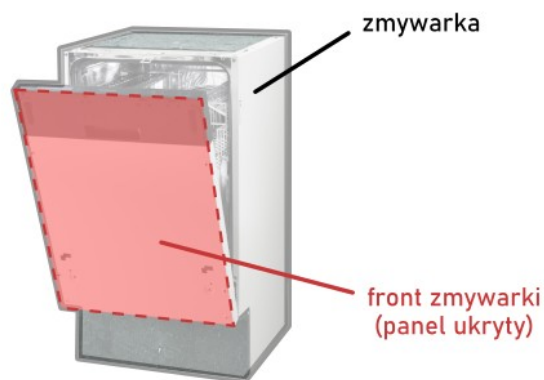

Panel zmywarkowy widoczny

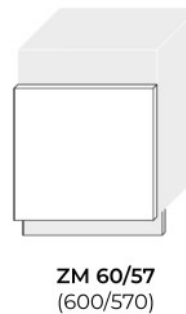
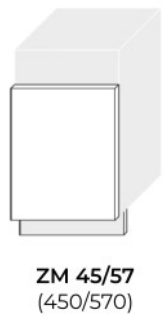

Panel zmywarkowy niewidoczny

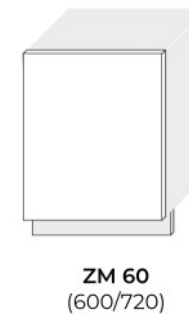
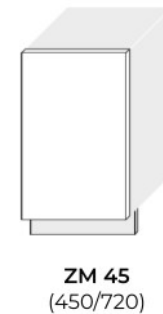



Wysokiej jakości system szuflad **METABOX / BLUM** zapewniają wysoką stabilność, także w przypadkach **maksymalnego obciążenia, które wynosi 30 kg.** Brak cichego domyknięcia w standardzie\*.

(szer./wys./gł.)

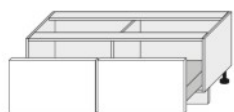

**D2M/120** ●  
(1200/460/500)



**D4M 40** ●  
(400/820/500)



**D3M 50** ●  
(500/820/500)

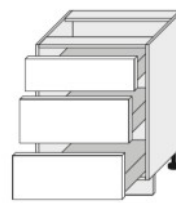

**D3M 60** ●  
(600/820/500)

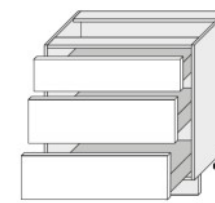

**D3M 80** ●  
(800/820/500)

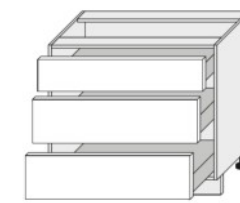

**D3M 90** ●  
(900/820/500)



Szuflady dostępne w kolorze szarym.

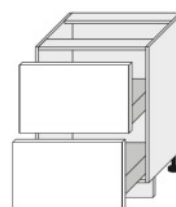

**D2M 60** ●  
(600/820/500)

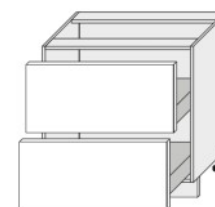

**D2M 80** ●  
(800/820/500)

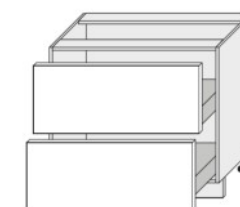

**D2M 90** ●  
(800/820/500)

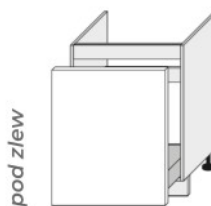

**D1ZM 60** ●  
(600/820/500)

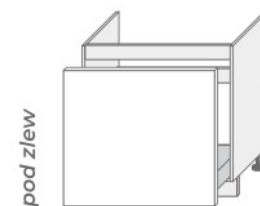

**D1ZM 80** ●  
(800/820/500)

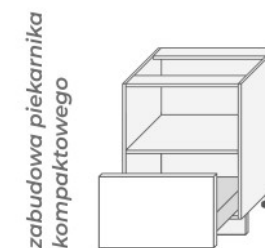

**D11K M/60 KOMPAKT** ●  
(600/820/500)

● - brak cichego domyknięcia\* w standardzie. Opcja dodatkowo płatna.

\*Do szuflady METABOX z częściowym wysuwem można zastosować sprawdzoną funkcję **BLUMOTION** - jest to dodatkowy hamulec do szuflady, który należy dodatkowo zakupić i zamontować.

Szuflady z serii **COMFORT BOX** to innowacyjne produkty umożliwiające utrzymanie porządku na najwyższym poziomie. **Ładowność do 35kg. Pełny wysuw, prowadnica z miękkim dociąganiem.**



(szer./wys./gł.)

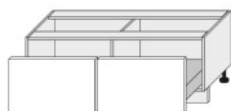

**D2R/120**  
(1200/460/500)

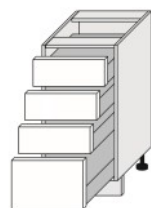

**D4R 40**  
(400/820/500)



**D3R 50**  
(500/820/500)

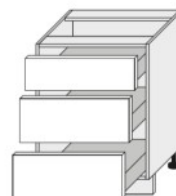

**D3R 60**  
(600/820/500)

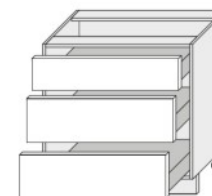

**D3R 80**  
(800/820/500)

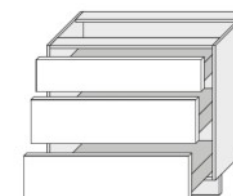

**D3R 90**  
(900/820/500)

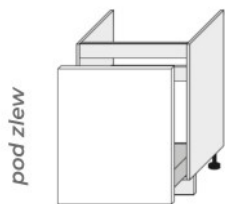

**D1ZR 60**  
(600/820/500)

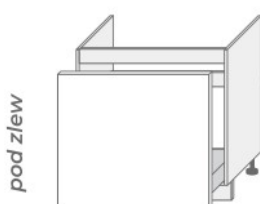

**D1ZR 80**  
(800/820/500)

zabudowa piekarnika  
kompaktowego

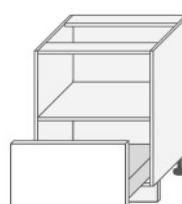

**D11K R/60 KOMPAKT**  
(600/820/500)

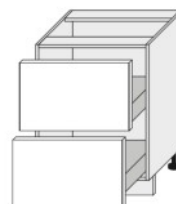

**D2R 60**  
(600/820/500)

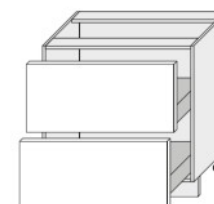

**D2R 80**  
(800/820/500)

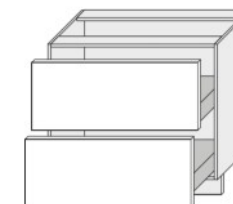

**D2R 90**  
(900/820/500)

PROWADNICE W KOLORZE BIAŁYM.





Wysokiej jakości system szuflad **InnoTech ATIRA** wyposażonych w pełen wysuw oraz **ciche domykanie**.  
maksymalne obciążenie do **30 kilogramów**.

(szer./wys./gł.)



**D2A/120**  
(1200/460/500)



**D4A 40**  
(400/820/500)

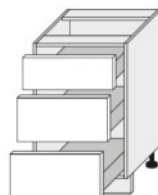

**D3A 50**  
(500/820/500)

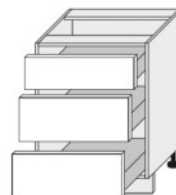

**D3A 60**  
(600/820/500)

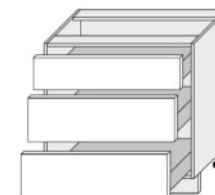

**D3A 80**  
(800/820/500)

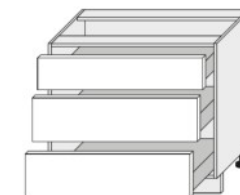

**D3A 90**  
(900/820/500)

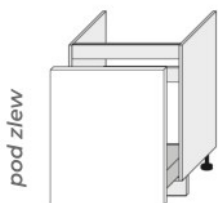

**D1ZA 60**  
(600/820/500)

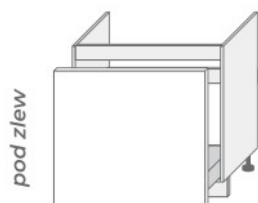

**D1ZA 80**  
(800/820/500)

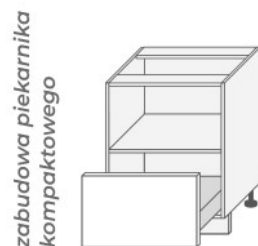

**D11K A/60 KOMPAKT**  
(600/820/500)

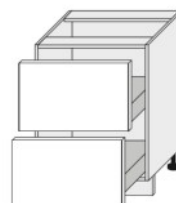

**D2A 60**  
(600/820/500)

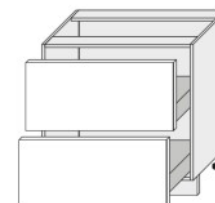

**D2A 80**  
(800/820/500)

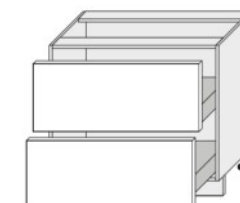

**D2A 90**  
(900/820/500)



**PROWDANICE W KOLORZE CZARNYM.**

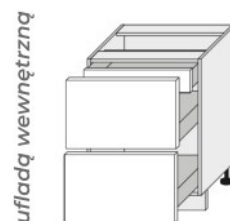

**D2A/60/1A**  
(600/820/500)

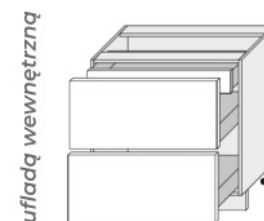

**D2A/80/1A**  
(800/820/500)



**D2A/90/1A**  
(900/820/500)

# SZAFKI STOJĄCE, NAROŻNE

(szer./wys./gł.)

90 cm w blacie  
(84 cm bez blatu)    90 cm w blacie  
(84 cm bez blatu)

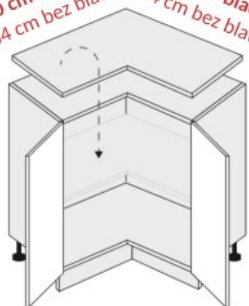

**D12 90 bez półki**  
(840/820/840)

półka dla D12 90



kosz obrotowy

90 cm w blacie  
(84 cm bez blatu)    90 cm w blacie  
(84 cm bez blatu)

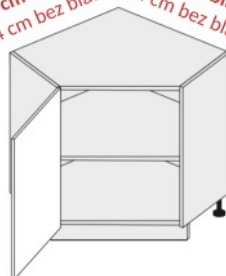

**D12R 90 L/P**  
(840/820/840)



kosz obrotowy

105 cm w blacie  
(90 cm bez blatu) / 63 cm w blacie  
(50 cm bez blatu)

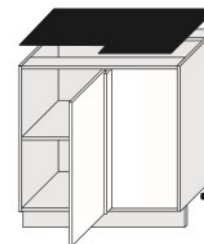

**D13U 90 L/P**  
(900/820/500)

● - brak cichego domykania\* w standardzie. Opcja dodatkowo płatna.

## SŁUPKI 154 CM

(szer./wys./gł.)

**blum**

pod piekarnik i mikrofalę

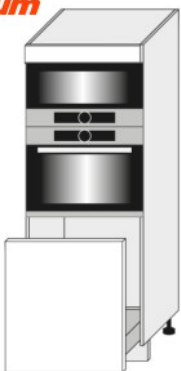

**D5AM 60 / 154** ●  
(600/1540/565)

**REJS**

pod piekarnik i mikrofalę

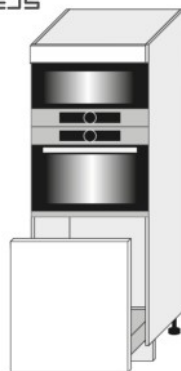

**D5AR 60 / 154**  
(600/1540/565)

**Hettich**

pod piekarnik i mikrofalę



**D5AA 60 / 154**  
(600/1540/565)

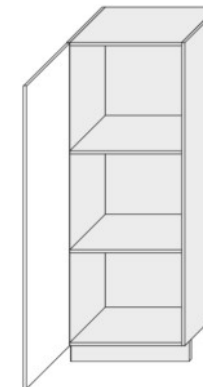

**D5D 60 / 154 L**  
(600/1540/565)



**KOSZ MIDI**  
dla D5D 60

# SŁUPKI 207 CM

(szer./wys./gł.)

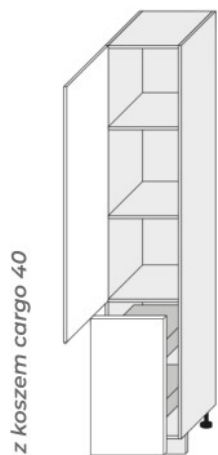

z koszem cargo 40

**2D14K 40 L/P**  
(400/2070/565)

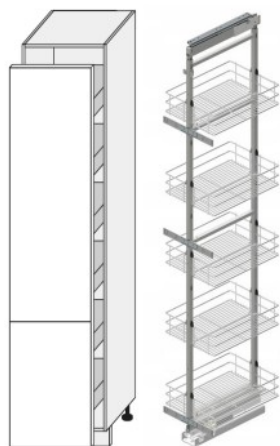

**2D14K 40 + kosz MAXI 40**  
(400/2070/565)

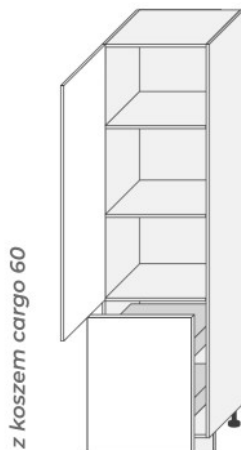

z koszem cargo 60

**D14DP 60 L/P**  
(600/2070/565)

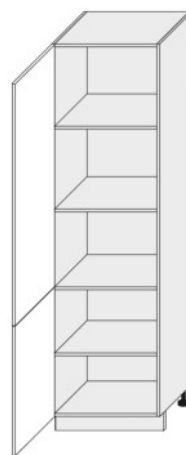

**D14 DP 60 L/P**  
(600/2070/565)

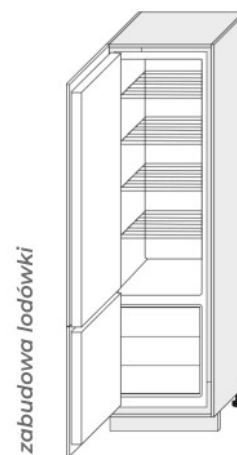

zabudowa lodówki

**D14 DL 60 L/P**  
(600/2070/565)

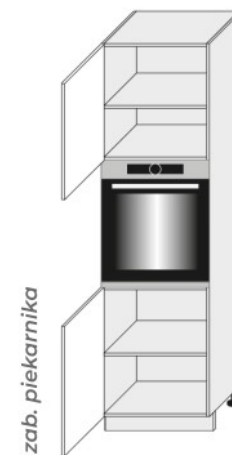

zab. piekarnika

**D14 RU 2D 60 L**  
(600/2070/565)

**blum**

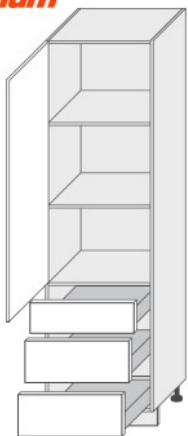

**D/14/DP/3M L** ●  
(600/2070/565)

**REJS**

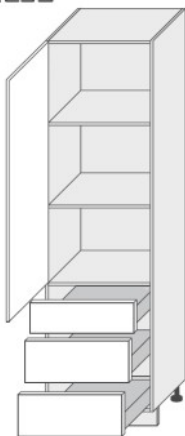

**D/14/DP/3R L**  
(600/2070/565)

**Hettich**

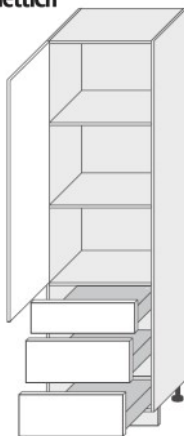

**D/14/DP/3A L**  
(600/2070/565)





**D14 RU 2M KOMPAKT** ●  
(600/2070/565)

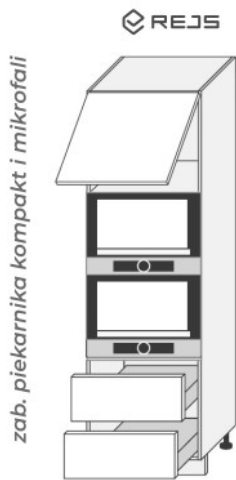

**D14 RU 2R KOMPAKT**  
(600/2070/565)

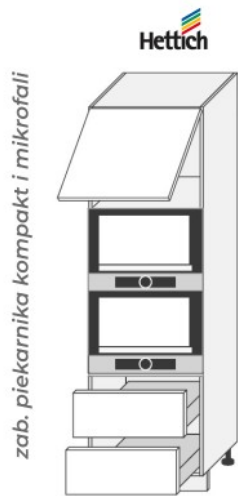

**D14 RU 2A KOMPAKT**  
(600/2070/565)

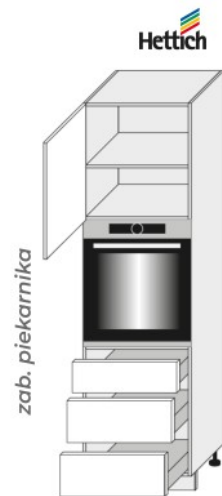

**D14 RU 3A 60 L**  
(600/2070/565)

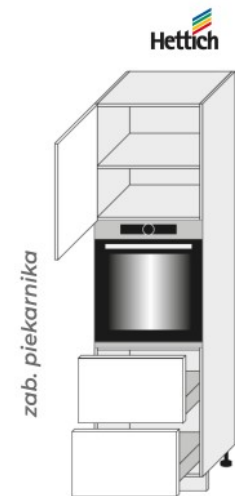

**D14 RU 2A 60 356 L**  
(600/2070/565)



**D14 RU 2A 60 284**  
(600/2070/565)

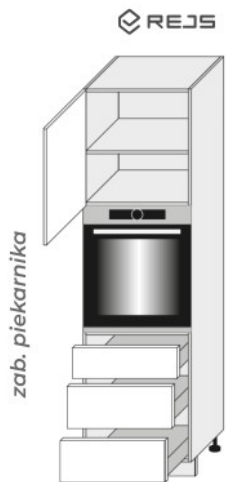

**D14 RU 3R 60 L**  
(600/2070/565)



**D14 RU 2R 60 356 L**  
(600/2070/565)



**D14 RU 2R 60 284**  
(600/2070/565)

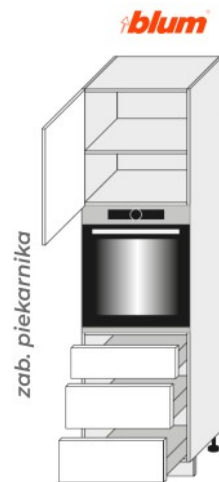

**D14 RU 3M 60 L** ●  
(600/2070/565)

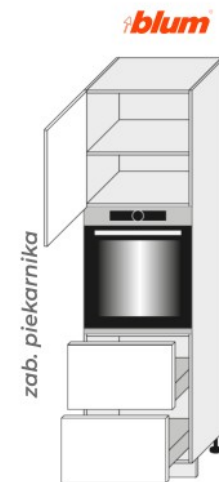

**D14 RU 2M 60 356 L** ●  
(600/2070/565)

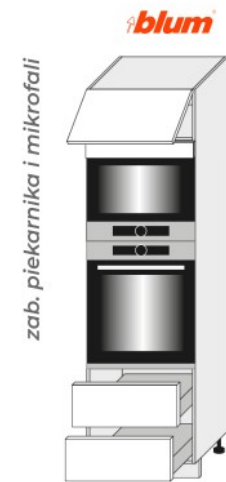

**D14 RU 2M 60 284** ●  
(600/2070/565)



# WYMIARY AGD DO NASZYCH SZAFEK

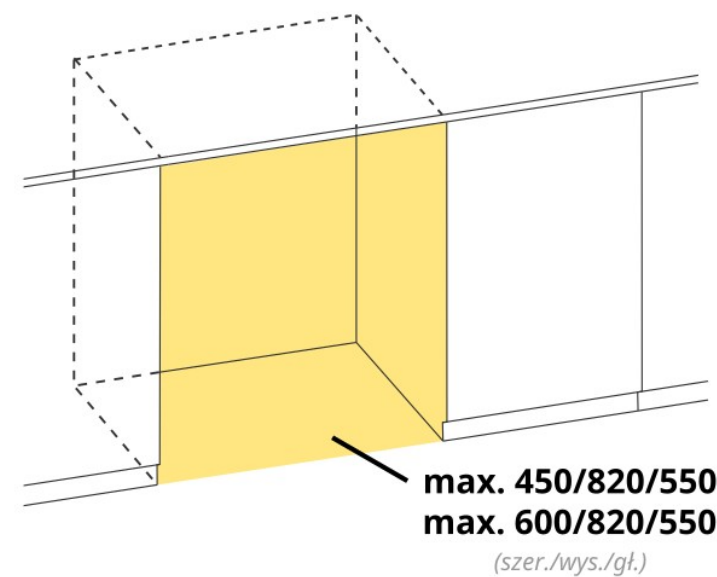
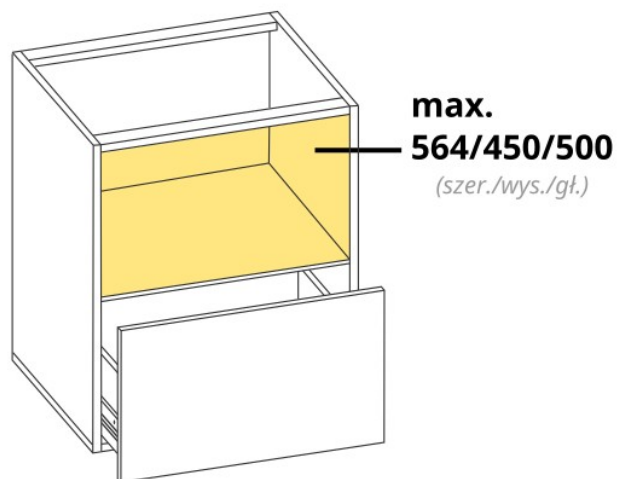
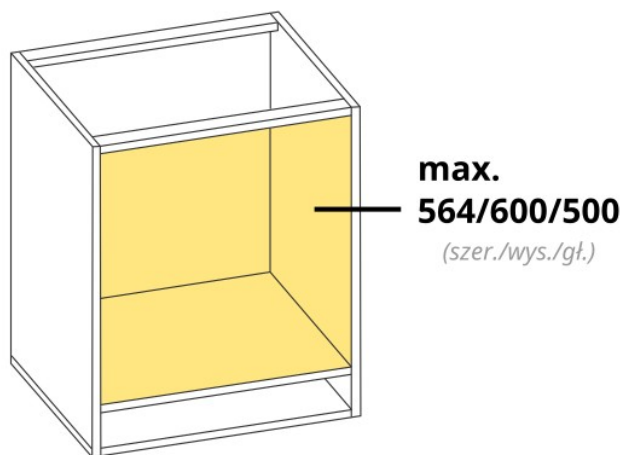
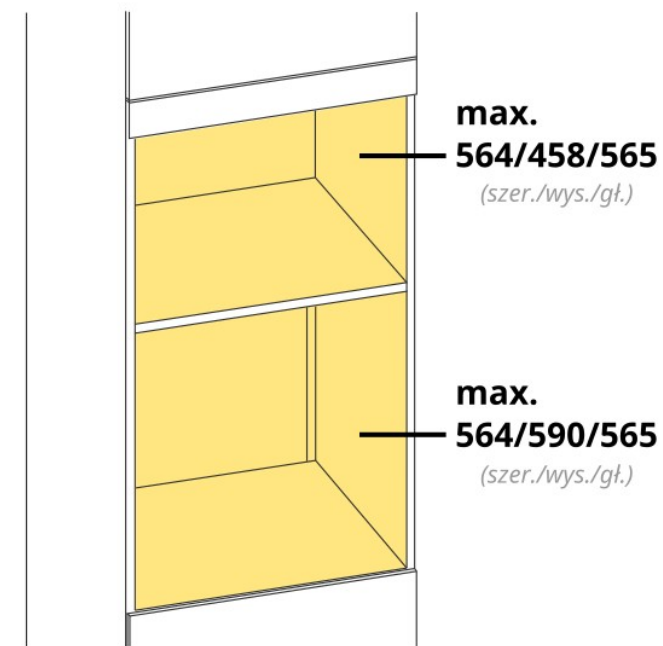
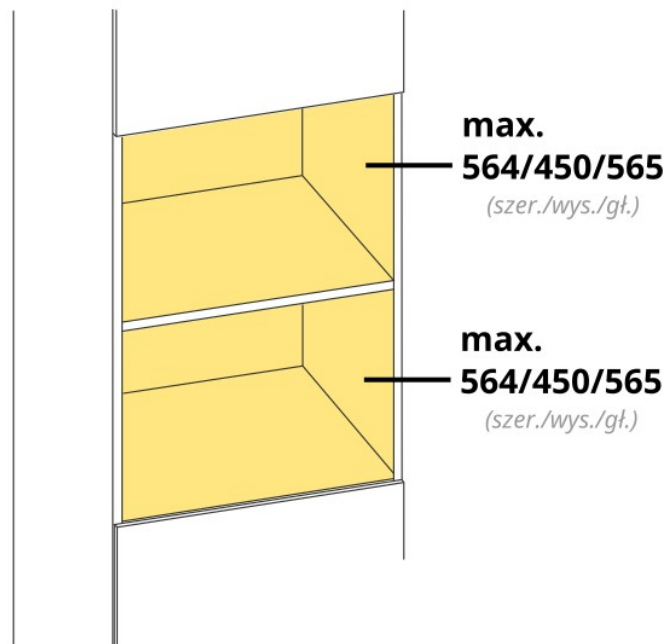
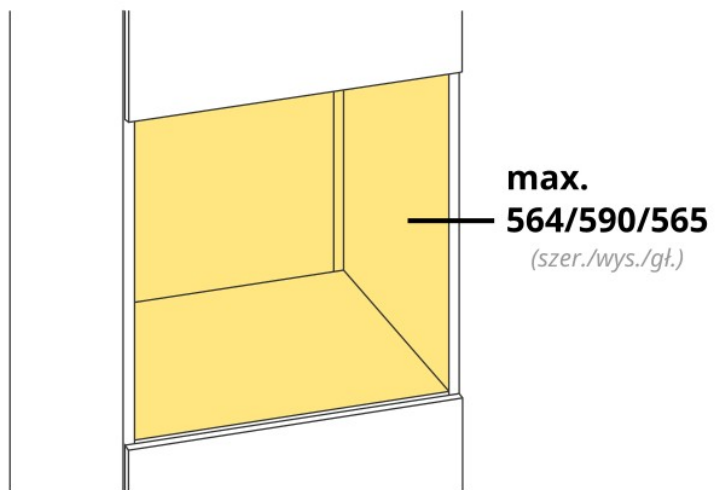

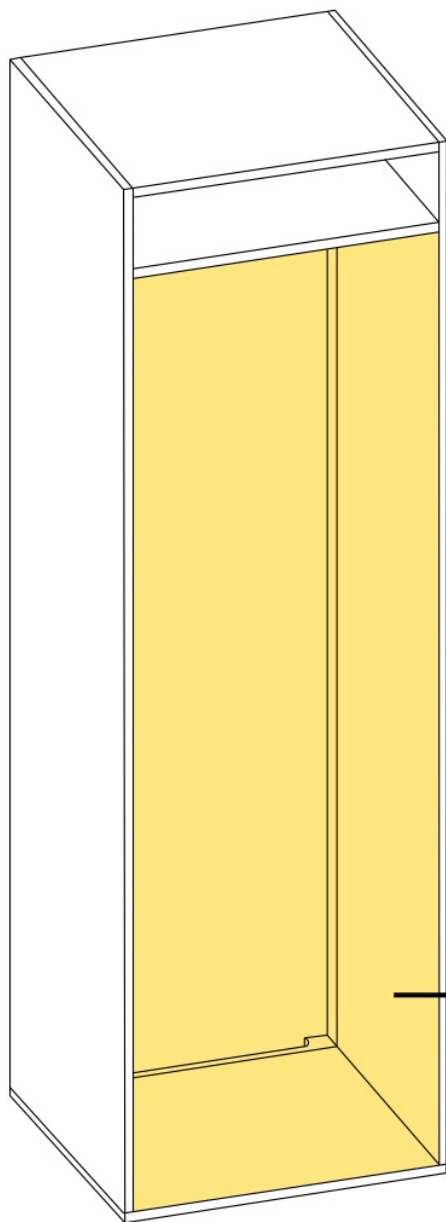

**max.**  
**1780/564/565**  
*(szer./wys./gł.)*

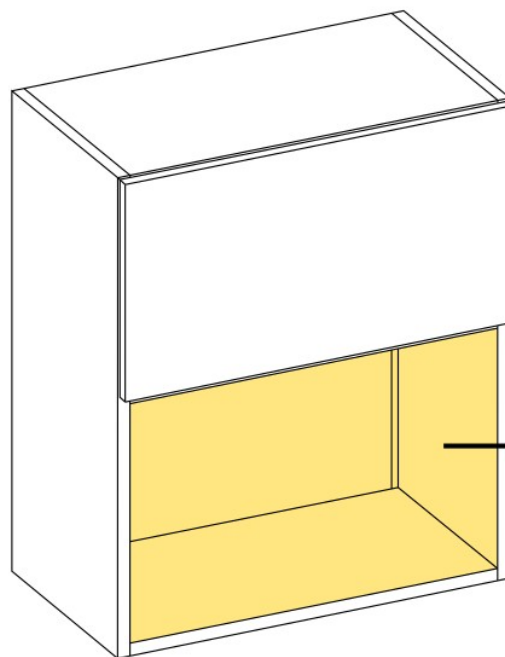

**max.**  
**564/360/305-325\***  
*(szer./wys./gł.)*

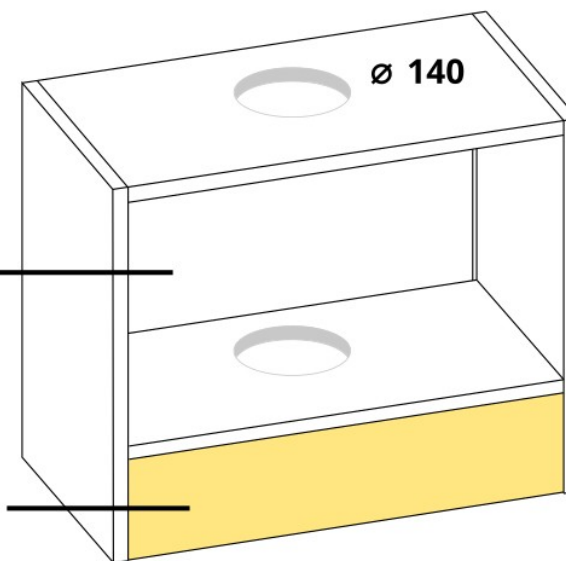

**max.**  
**564/329/305**  
*(szer./wys./gł.)*

**max.**  
**564/135/305**  
*(szer./wys./gł.)*

## W NASZEJ OFERCIE ZNAJDZIESZ RÓWNIEŻ



blaty laminowane na wymiar  
według potrzeb klienta



uchwyty standardowe, gałki,  
uchwyty krawędziowe



pojemniki na odpady,  
szuflady z pojemnikami  
na odpady

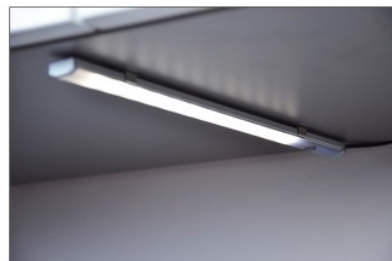

oświetlenie podszawkowe,  
szafkowe oraz cokołów



możliwość zakupu  
pojedynczych frontów  
lub korpusów



kosze cargo, nóżki cokołowe,  
listwy, spawalnicze, stelaże  
metalowe i wiele więcej...

O SZCZEGÓŁY PYTAJ HANDLOWCÓW

[ewa@kosbel.pl](mailto:ewa@kosbel.pl)

[filip@kosbel.pl](mailto:filip@kosbel.pl)

Katalog nie stanowi oferty w rozumieniu prawa i jest publikowany jedynie dla celów informacyjnych. Prowadząc politykę ciągłego rozwoju zastrzegamy sobie prawo do zmian i ulepszeń produktów przedstawionych w katalogu bez uprzedniego powiadomienia. Kolorystyka przedstawiona w katalogu może się różnić od rzeczywistej. Zastrzegamy sobie prawo do błędów w druku.