

OPRAWA HERMETYCZNA PODWÓJNA

NEXTEC LED HERMETIC FIXTURE DOUBLE



PF035816
PF035823

120 cm



	OPRAWY HERMETYCZNE	
	PF035816	PF035823
EAN	5908293935816	5908293935823
Rozmiar / Size	120 cm	
Moc / Power	48 W	
Napięcie / Voltage	AC 220-240V	
Barwa / Colour	4000K	5700K
CRI	Ra>80	
Kąt świecenia / Beam angle	180 °	
IP	IP65	
lm	5800 lm	
lm/W	120	120
Ilość LED / LED Quantity	150 x 2835	
Temp. pracy / working temp.	-30 ~ +45 °C	
Żywotność / Life time	30,000 godz./h / On/Off: 15000x	
Waga	1390 g	
Wymiary	1200x100x70 mm	

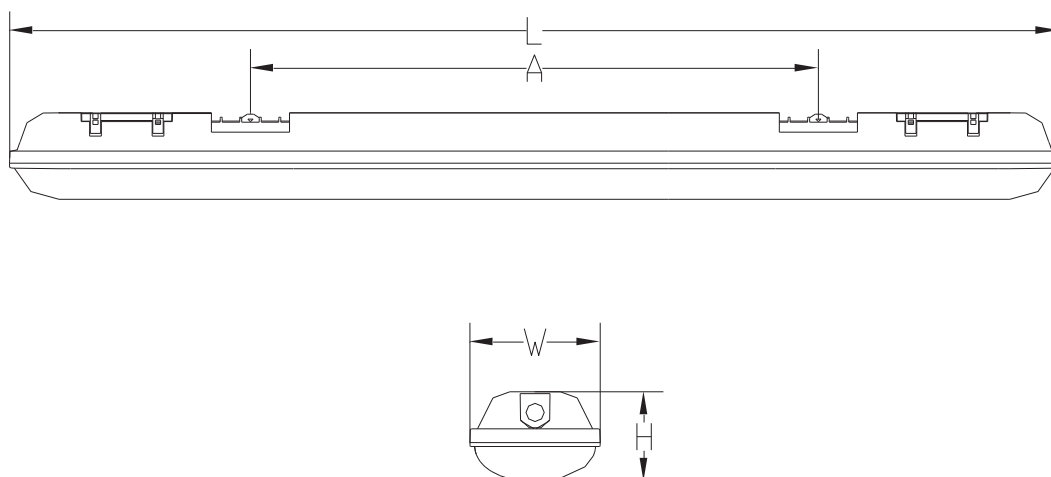

Wymiary / Dimensions (mm)				
Długość / Length	Szerokość / Width	Wysokość / Height	A	B
1200	100	68	850	26

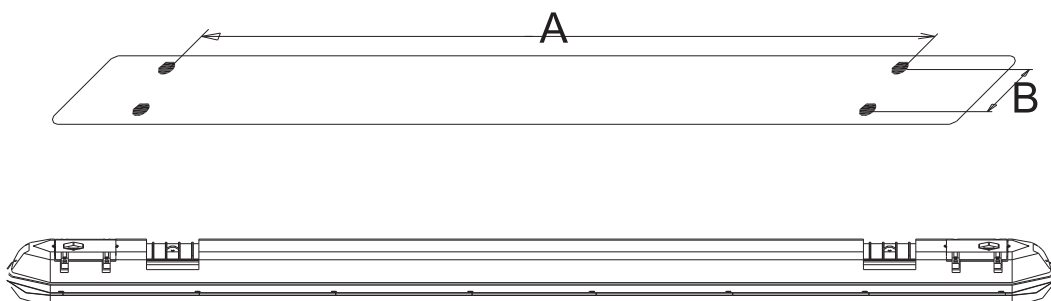

JESTEŚMY ZBUDOWANE Z...

We are built of...

**Obudowa i klosz z POLIWĘGLANU (PC)
+ HONGLI 2835 LED**

PC body, PC cover + HONGLI 2835 LED
(PC - Polycarbonates)

