

+48 734 481 529 filip@kosbel.pl

Infolinia czynna: pon. - pt. 8:00 - 14:00

+48 608 567 678 ewa@kosbel.pl

Infolinia czynna: pon. - pt. 12:00 - 18:00



Simple

SERIA SIMPLE (laminat)



ZIELEŃ
LABRADOR



BIAŁY
PLATYNOWY



DĄB ARTISAN



FRESCO
ANTRACYT



CRAFT OAK



DĄB
SONOMA



Fronty wykonane z solidnej płyty meblowej o grubości **16 mm**.



Nóżki regulowane (10 cm) umożliwiają precyzyjne ustawienie szafki nawet na nierównym podłożu.

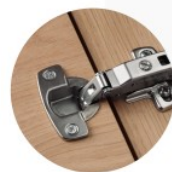

Zawiasy HETTICH
Solidne i wytrzymałe zawiasy wyposażone w ciche domykanie.

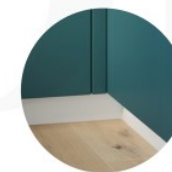

Cokół (10 cm) docięty do szerokości szafki dołączony jest do każdej paczki.

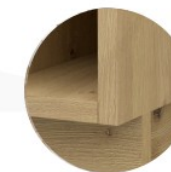

Korpusy wykonane z płyty meblowej o grubości **18 mm**.

- **Krawędzie** frontów oklejone są obrzeżem ABS o grubości 2 mm. Pokrycie obejmuje również wewnętrzną stronę frontów.
- **Dostępna opcja LONG**, czyli możliwość wykonania dłuższego od korpusu frontu a dolna „wystająca” część tworzy uchwyt (o cenę pytaj handlowca)

DOSTĘPNE KOLORY KORPUSÓW

Korpusy wykonane są z płyty meblowej,
laminowanej o grubości **18 mm**.



LAVA



GREY



BIAŁY



DĄB ARTISAN



Wysokiej jakości zawias Hettich
z cichym domykaniem* w standardzie.



Wysokość szafek wiszących
360 / 720 / 960 mm

Głębokość* szafek wiszących
325 mm

Wysokość szafek stojących
z nóżkami i cokołem
820 / 154 / 2070 mm

Głębokość* szafek stojących
500 mm

Głębokość* słupków wysokich
565 mm

SZAFKI WISZĄCE / 72 CM



Solidne i wytrzymałe, zawiasy **HETTICH** z cichym zamykaniem.



Zawieszki regulowane, umożliwiają łatwe i precyzyjne zawieszenie szafek.



Zalecamy stosowanie listw montażowych.

(szer./wys./gł.)

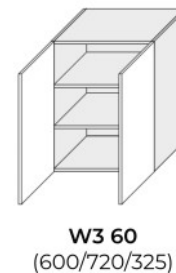
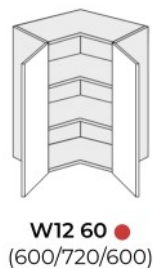
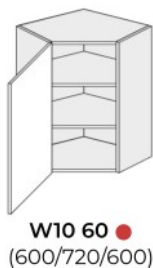
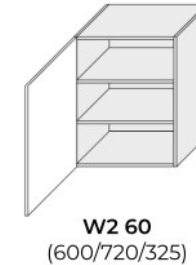
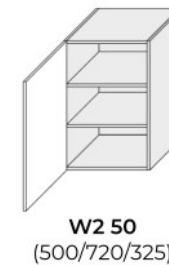
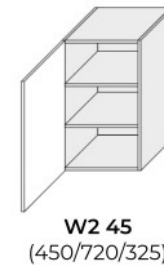
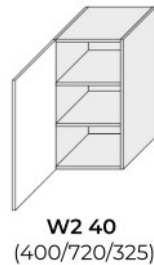
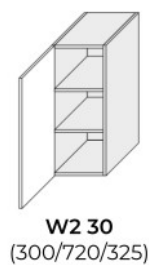
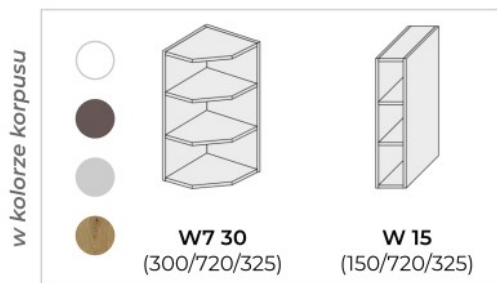

● - brak cichego domykania* w standardzie.
Opcja dodatkowo płatna.

NOWOŚĆ! Fronty long, czyli możliwość wykonania dłuższego od korpusu frontu a dolna „wystająca” część tworzy uchwyt (o cenę pytaj handlowca)

SZAFKI WISZĄCE / 36 CM

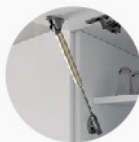

Zastosowanie **teleskopów gazowych** w szafkach otwieranych do góry.



Zawieszki regulowane, umożliwiają łatwe i precyzyjne zawieszenie szafek.

(szer./wys./gł.)



W4B 30
(300/360/325)

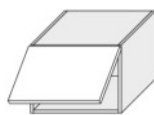

W4B 50
(500/360/325)

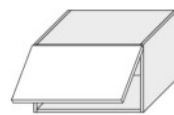

W4B 60
(600/360/325)

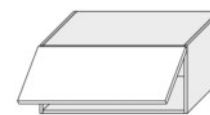

W4B 80
(800/360/325)

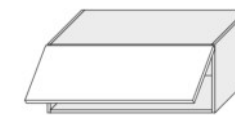

W4B 90
(900/360/325)



W4BS 60 LAM*
(600/360/325)

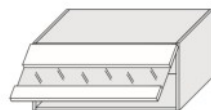

W4BS 80 LAM*
(800/360/325)

LAM - szyba w ramce z płyty meblowej, ramka w kolorze frontu

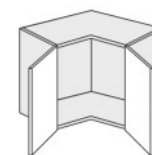

W12/60 ●
(600/360/600)



W10/60 ●
(600/360/600)

NADSTAWKI

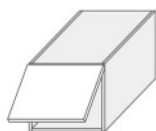

W6B 30
(300/360/565)
nadstawka



W6B 40
(400/360/565)
nadstawka

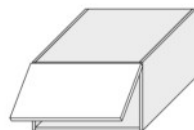

W6B 60
(600/360/565)
nadstawka

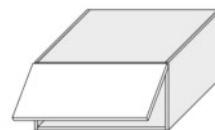

W6B 80
(800/360/565)
nadstawka

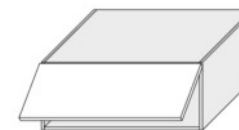

W6B 90
(900/360/565)
nadstawka



W14 90 ●
(900/360/900)
nadstawka narożna

● - **brak cichego domykania*** w standardzie.
Opcja dodatkowo płatna.

NOWOŚĆ! Fronty long, czyli możliwość wykonania dłuższego od korpusu frontu a dolna „wystająca” część tworzy uchwyt (o cenę pytaj handlowca)



System **AVENTOS** oraz **AVENTOS HK** firmy **BLUM**.
Komfort ruchu oraz swoboda
użytkowania każdego dnia.

(szer./wys./gł.)



W8B 60 AVENTOS
(600/720/325)



W8B 80 AVENTOS
(800/720/325)



W8B 90 AVENTOS
(900/720/325)



W4B 60 AVENTOS HK
(600/360/325)

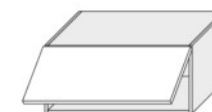

W4B 80 AVENTOS HK
(800/360/325)



W4B 90 AVENTOS HK
(900/360/325)



W8BS 60 AV WKF*
(600/720/325)



W8BS 80 AV WKF*
(800/720/325)



W8BS 90 AV WKF*
(900/720/325)

SZAFKA PRZYGOTOWANA POD OKAP

SZAFKA POD MIKROFAŁĘ

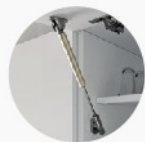

Zastosowanie **teleskopów gazowych** w szafkach otwieranych do góry.

(szer./wys./gł.)



zdjęcie przykładowe

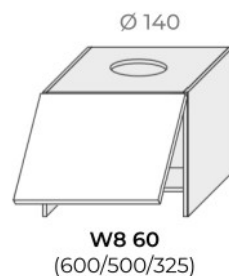

zdjęcie przykładowe



Szafka **PREMIUM** w korpusie **CZARNA PERŁA** z szybą przezroczystą w czarnej ramce aluminiowej.



zdjęcie przykładowe

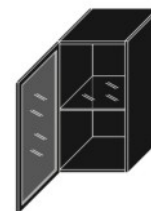

W2S 40 BLACK ALU
(400/720/325)

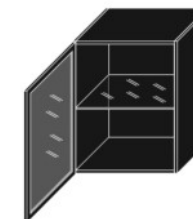

W3S 60 BLACK ALU
(600/720/325)

SZAFKI STOJĄCE



Solidne i wytrzymałe, zawiasy HETTICH z cichym zamykaniem.



Nóżki regulowane, umożliwiające precyzyjne ustawienie szafki nawet na nierównym podłożu.

(szer./wys./gt.)

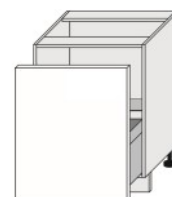
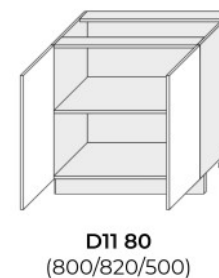
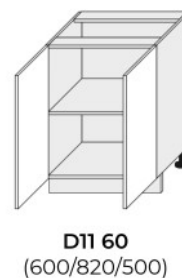
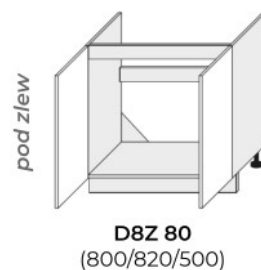
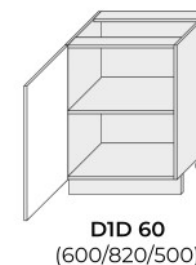
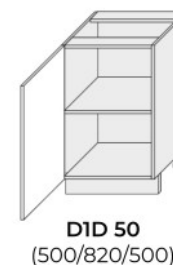
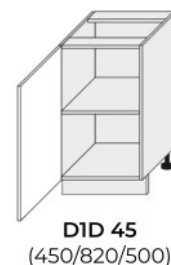
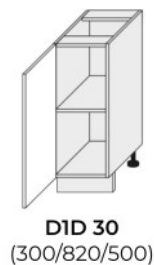
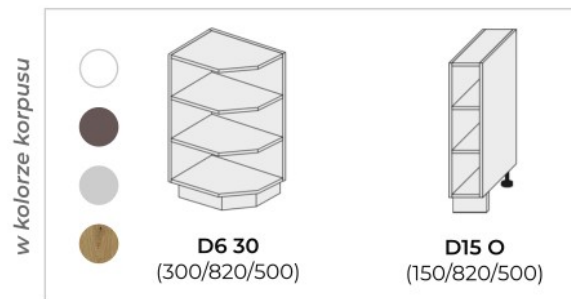

D1D 60 - szuflada SEGREGO
(600/820/500)



KOSZE CARGO

- prowadnica z montażem do dna korpusu • regulacja 3D • szybki montaż – system Click • możliwość zamontowania dodatkowej półki i uzyskania trzech poziomów
- możliwość zamontowania przegród do organizacji wewnętrznej • szablon montażowy w zestawie • dopuszczalne obciążenie 20kg

(szer./wys./gł.)

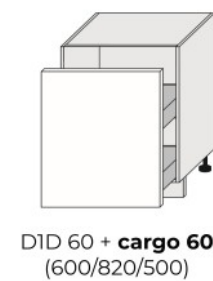
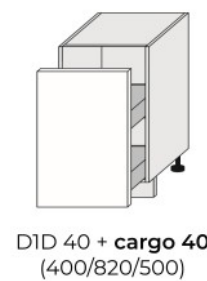

FRONTY ZMYWARKOWE

Zmywarki do zabudowy wymagają jedynie przedniego panelu. Do ich zabudowy nie jest wymagany dodatkowy korpus.

(szer./wys./gł.)

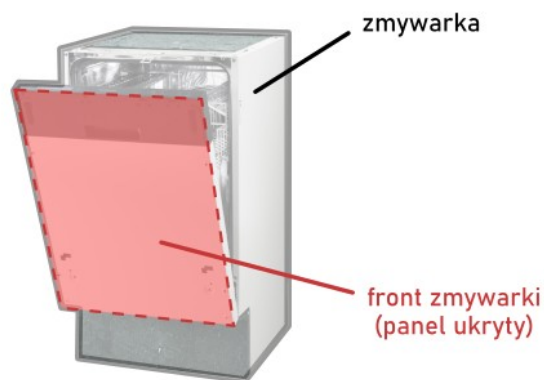

Panel zmywarkowy widoczny

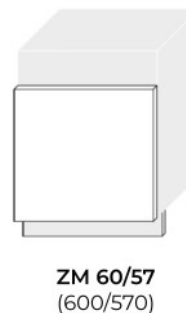
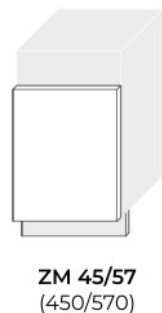

Panel zmywarkowy niewidoczny

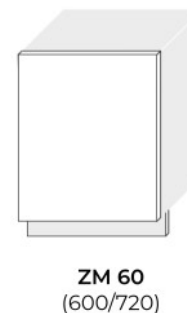
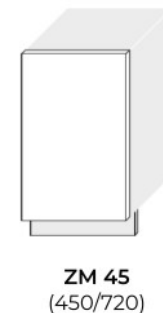



Wysokiej jakości system szuflad **METABOX / BLUM** zapewniają wysoką stabilność, także w przypadkach **maksymalnego obciążenia, które wynosi 30 kg.** Brak cichego domykania w standardzie*.

(szer./wys./gł.)



D2M/120 ●
(1200/460/500)

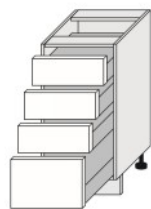

D4M 40 ●
(400/820/500)

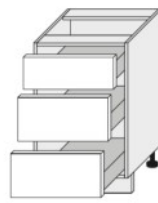

D3M 50 ●
(500/820/500)

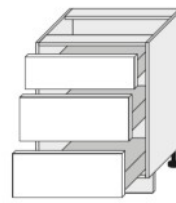

D3M 60 ●
(600/820/500)

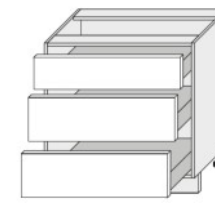

D3M 80 ●
(800/820/500)

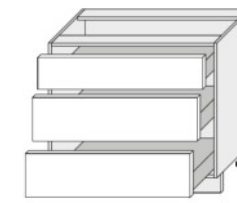

D3M 90 ●
(900/820/500)



Szuflady dostępne w kolorze szarym.

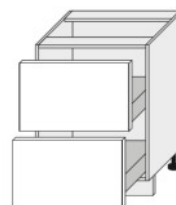

D2M 60 ●
(600/820/500)

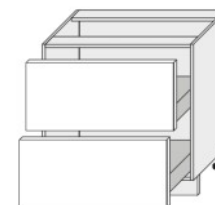

D2M 80 ●
(800/820/500)

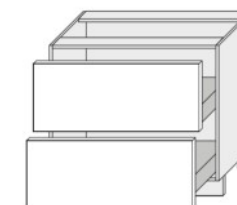

D2M 90 ●
(800/820/500)

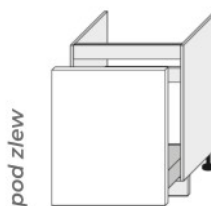

D1ZM 60 ●
(600/820/500)

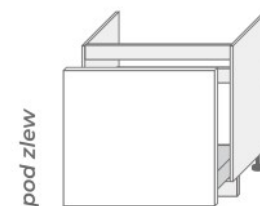

D1ZM 80 ●
(800/820/500)

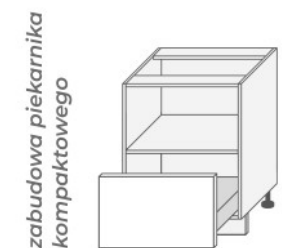

D11K M/60 KOMPAKT ●
(600/820/500)

● - brak cichego domykania* w standardzie. Opcja dodatkowo płatna.

*Do szuflady METABOX z częściowym wysuwem można zastosować sprawdzoną funkcję **BLUMOTION** - jest to dodatkowy hamulec do szuflady, który należy dodatkowo zakupić i zamontować.

Szuflady z serii **COMFORT BOX** to innowacyjne produkty umożliwiające utrzymanie porządku na najwyższym poziomie. **Ładowność do 35kg. Pełny wysuw, prowadnica z miękkim dociąganiem.**



(szer./wys./gł.)



D2R/120
(1200/460/500)

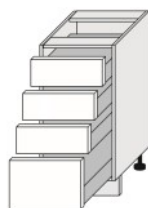

D4R 40
(400/820/500)



D3R 50
(500/820/500)

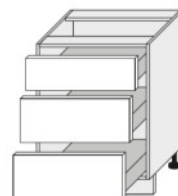

D3R 60
(600/820/500)

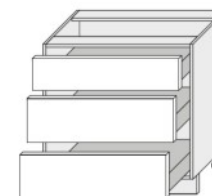

D3R 80
(800/820/500)

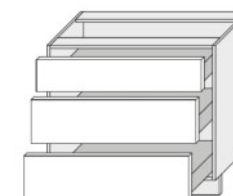

D3R 90
(900/820/500)

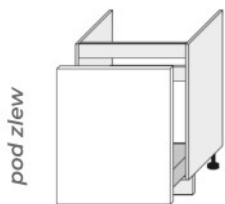

D1ZR 60
(600/820/500)

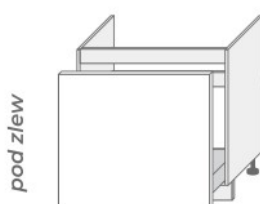

D1ZR 80
(800/820/500)

zabudowa piekarnika
kompaktowego

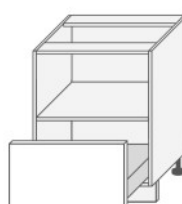

D11K R/60 KOMPAKT
(600/820/500)

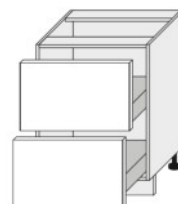

D2R 60
(600/820/500)

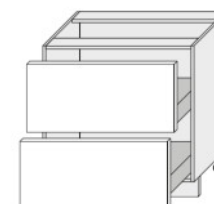

D2R 80
(800/820/500)

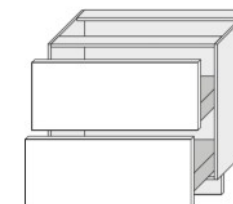

D2R 90
(900/820/500)

PROWADNICE W KOLORZE BIAŁYM.





Wysokiej jakości system szuflad **InnoTech ATIRA** wyposażonych w pełen wysuw oraz **ciche domykanie**.
maksymalne obciążenie do **30 kilogramów**.

(szer./wys./gł.)



D2A/120
(1200/460/500)



D4A 40
(400/820/500)

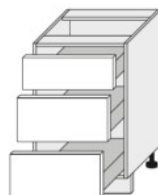

D3A 50
(500/820/500)

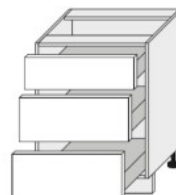

D3A 60
(600/820/500)

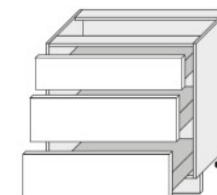

D3A 80
(800/820/500)

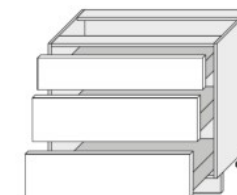

D3A 90
(900/820/500)

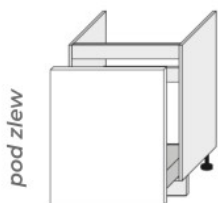

D1ZA 60
(600/820/500)

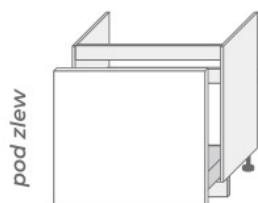

D1ZA 80
(800/820/500)

*zabudowa piekarnika
kompaktowego*

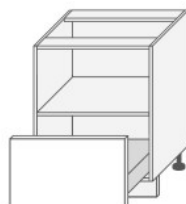

D11K A/60 KOMPAKT
(600/820/500)

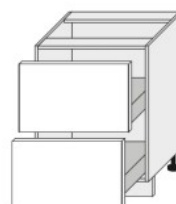

D2A 60
(600/820/500)

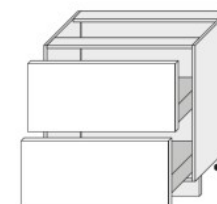

D2A 80
(800/820/500)

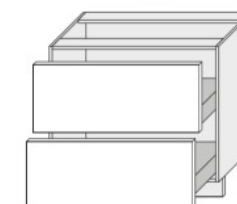

D2A 90
(900/820/500)



PROWDANICE W KOLORZE CZARNYM.

z szufladą wewnętrzną

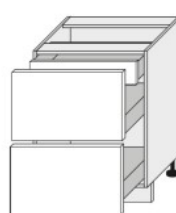

D2A/60/1A
(600/820/500)

z szufladą wewnętrzną

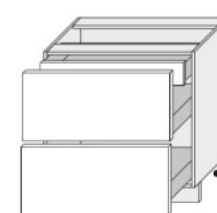

D2A/80/1A
(800/820/500)

z szufladą wewnętrzną

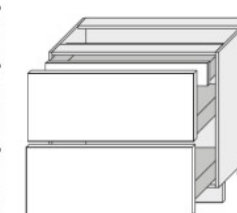

D2A/90/1A
(900/820/500)

SZAFKI STOJĄCE, NAROŻNE

(szer./wys./gł.)

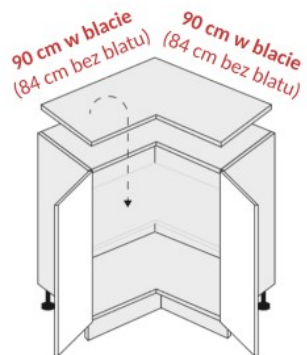

D12 90 bez półki
(840/820/840)

półka dla D12 90



kosz obrotowy

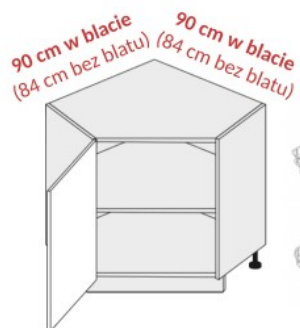

D12R 90
(840/820/840)



kosz obrotowy

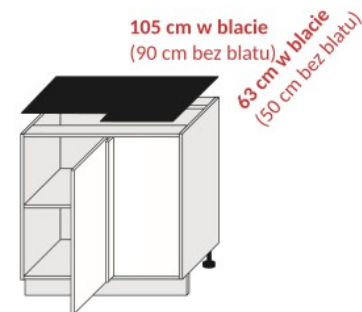

D13U 90 L/P
(900/820/500)

● - brak cichego domykania* w standardzie. Opcja dodatkowo płatna.

SŁUPKI 154 CM

(szer./wys./gł.)



D5AM 60 / 154 ●
(600/1540/565)



D5AR 60 / 154
(600/1540/565)



D5AA 60 / 154
(600/1540/565)

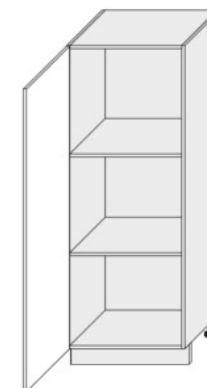

D5D 60 / 154
(600/1540/565)



KOSZ MIDI
dla D5D 60

SŁUPKI 207 CM

(szer./wys./gł.)

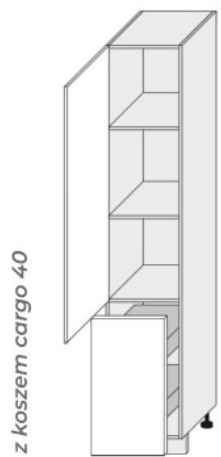

z koszem cargo 40

2D14K 40
(400/2070/565)

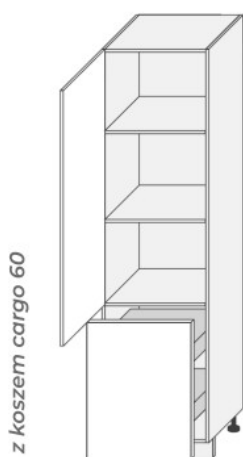

z koszem cargo 60

D14DP 60
(600/2070/565)

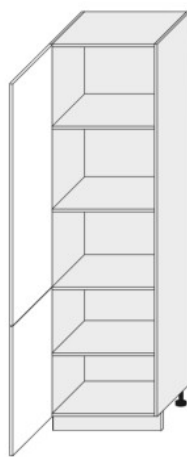

D14 DP 60
(600/2070/565)

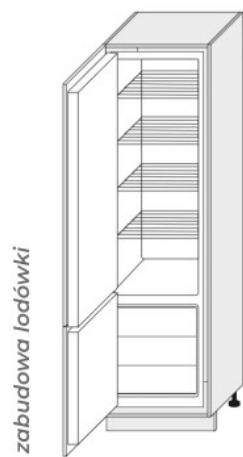

zabudowa lodówki

D14 DL 60
(600/2070/565)

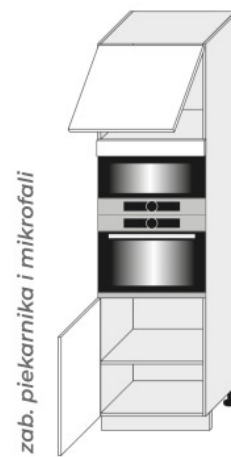

zab. piekarnika i mikrofalni

D14 RU 60
(600/2070/565)



zab. piekarnika

D14 RU 2D 60
(600/2070/565)

blum

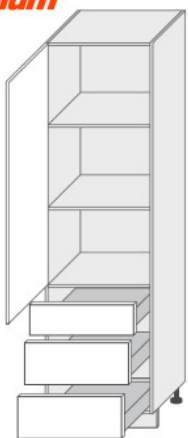

D/14/DP/3M ●
(600/2070/565)

REJS

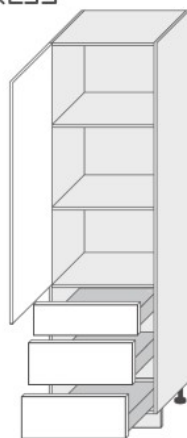

D/14/DP/3R
(600/2070/565)

Hettich

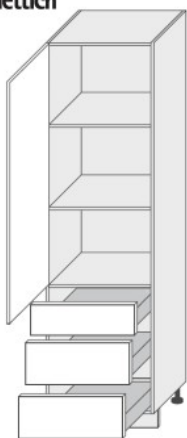

D/14/DP/3A
(600/2070/565)





D14 RU 2M KOMPAKT ●
(600/2070/565)

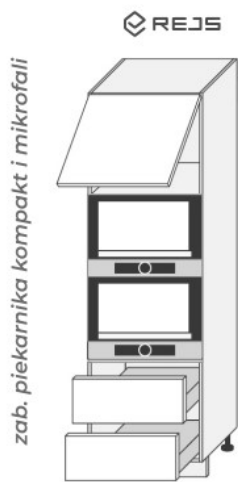

D14 RU 2R KOMPAKT
(600/2070/565)

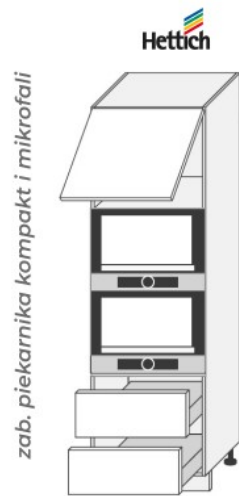

D14 RU 2A KOMPAKT
(600/2070/565)



D14 RU 3A 60
(600/2070/565)

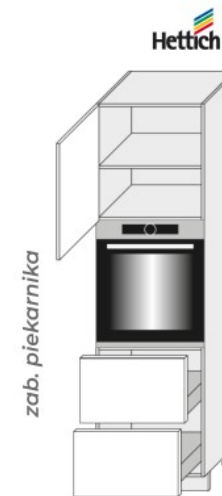

D14 RU 2A 60 356
(600/2070/565)



D14 RU 2A 60 284
(600/2070/565)

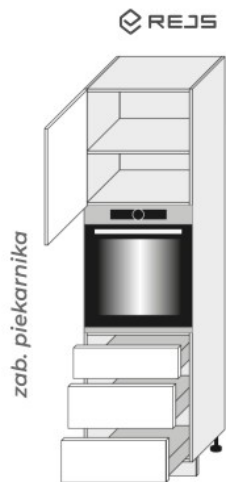

D14 RU 3R 60
(600/2070/565)

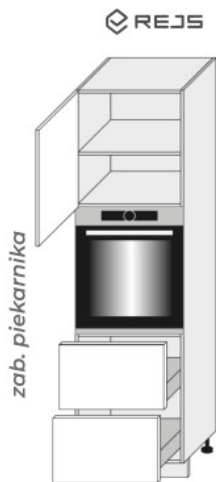

D14 RU 2R 60 356
(600/2070/565)

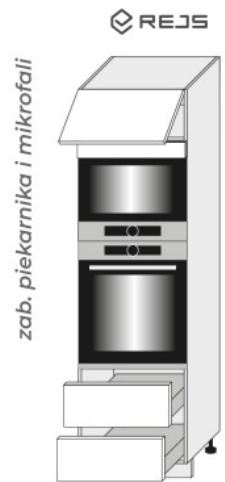

D14 RU 2R 60 284
(600/2070/565)

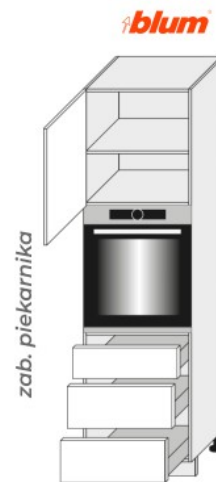

D14 RU 3M 60 ●
(600/2070/565)

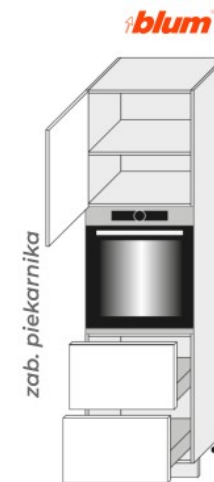

D14 RU 2M 60 356 ●
(600/2070/565)



D14 RU 2M 60 284 ●
(600/2070/565)

Szafki dostępne wyłącznie w korpusie **DĄB ARTISAN**

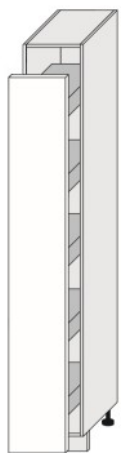

1D14K / 20 / CARGO
(200/2070/565)

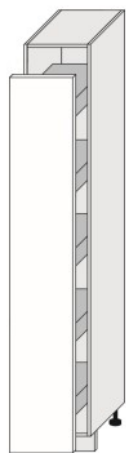

1D14K / 30 / CARGO
(600/2070/565)

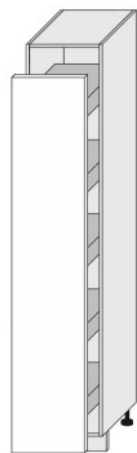

1D14K / 40 / CARGO
(600/2070/565)

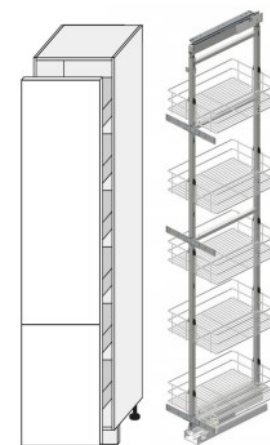

2D14K 40 + kosz MAXI 40
(400/2070/565)



Meble Kosbel

www.kosbel.pl



[kosbel.pl](https://www.instagram.com/kosbel.pl)

WYMIARY AGD DO NASZYCH SZAFEK

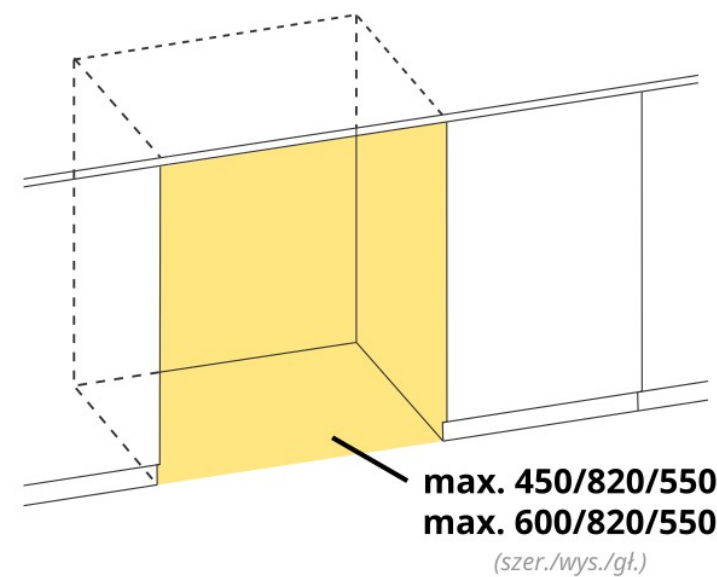
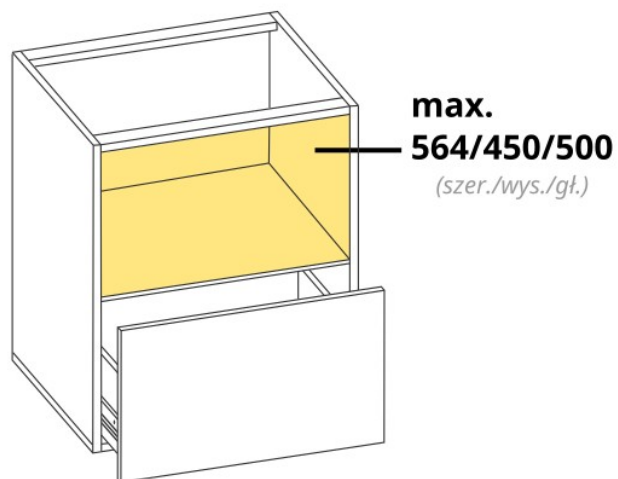
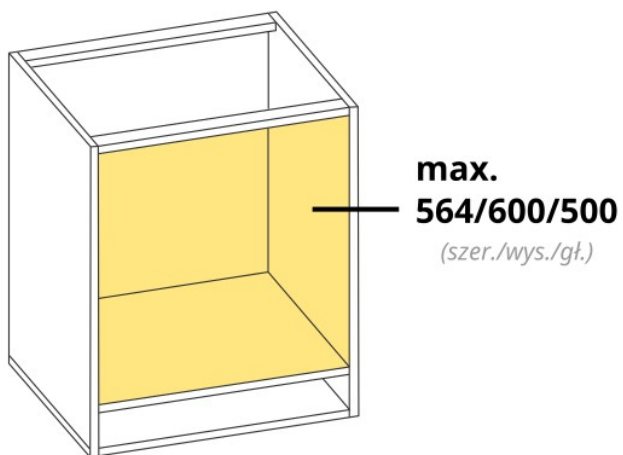
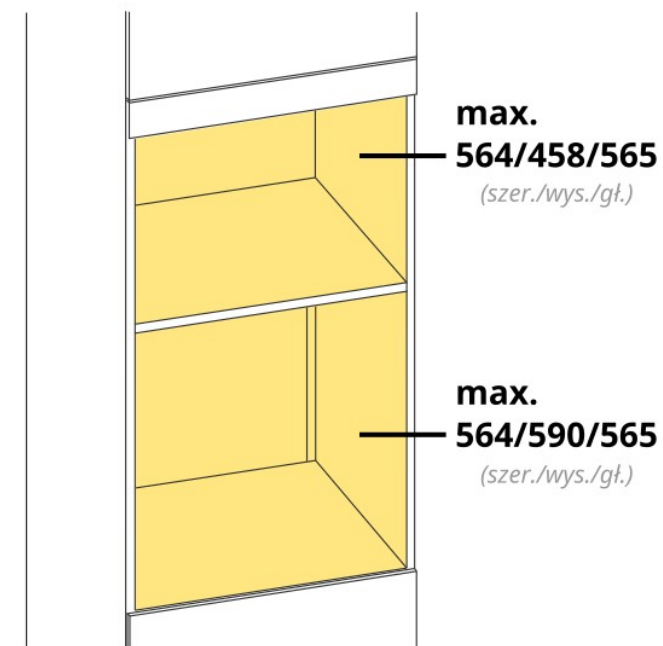
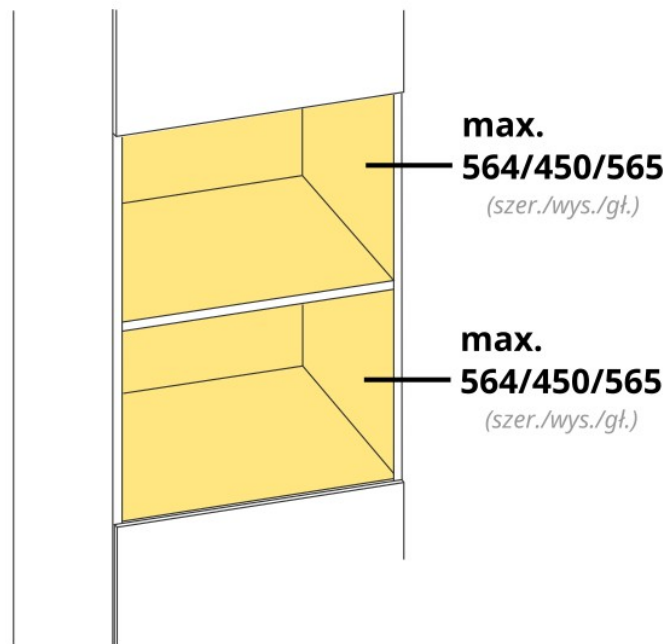
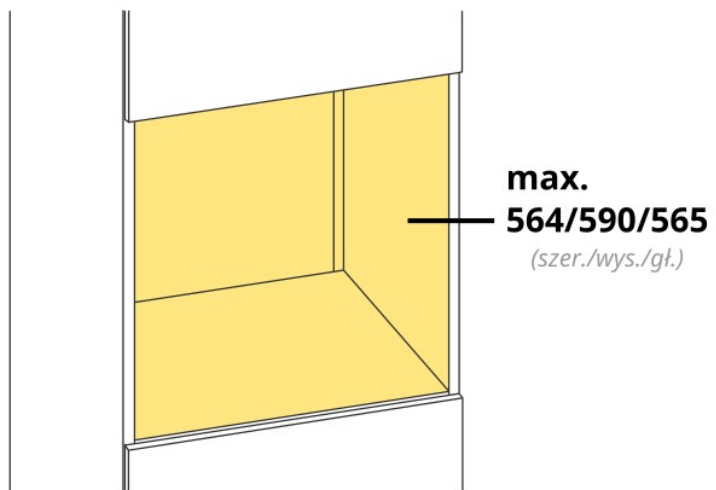

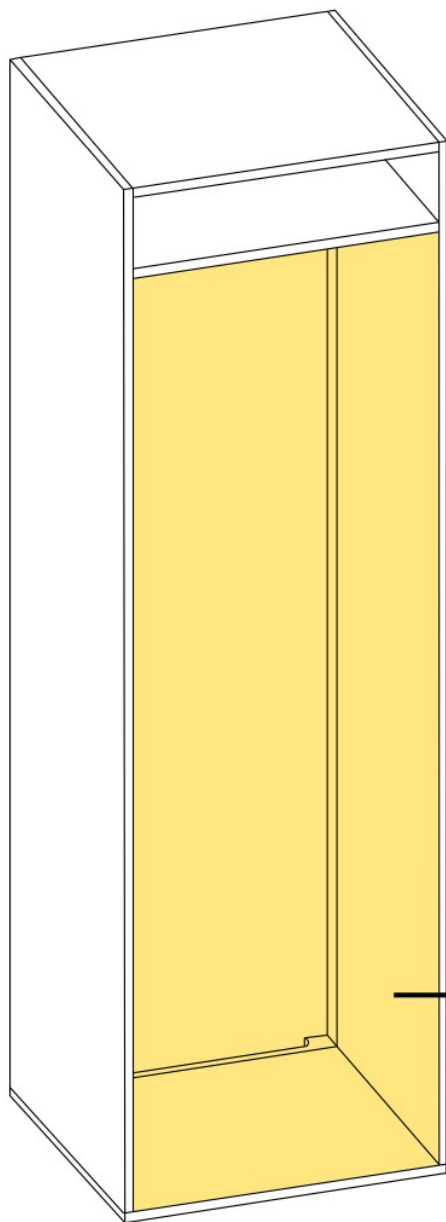

max.
1780/564/565
(szer./wys./gł.)

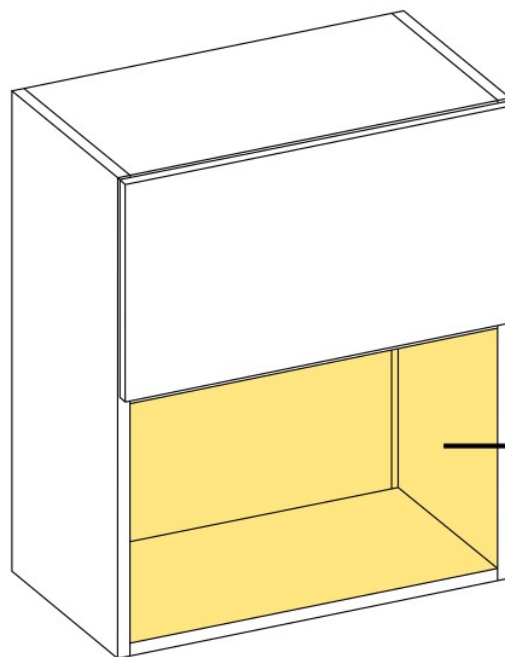

max.
564/360/305-325*
(szer./wys./gł.)

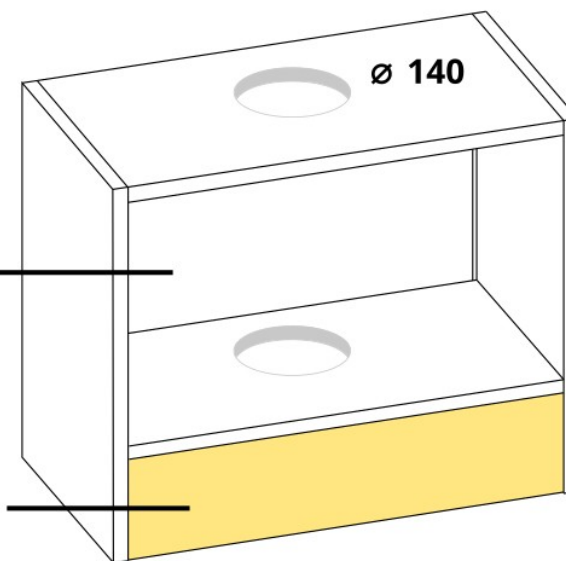

max.
564/329/305
(szer./wys./gł.)

max.
564/135/305
(szer./wys./gł.)

W NASZEJ OFERCIE ZNAJDZIESZ RÓWNIEŻ



blaty laminowane na wymiar
według potrzeb klienta



uchwyty standardowe, gałki,
uchwyty krawędziowe



pojemniki na odpady,
szuflady z pojemnikami
na odpady



oświetlenie podszawkowe,
szafkowe oraz cokołów



możliwość zakupu
pojedynczych frontów
lub korpusów



kosze cargo, nóżki cokołowe,
listwy, spawalnicze, stelaże
metalowe i wiele więcej...

O SZCZEGÓŁY PYTAJ HANDLOWCÓW

ewa@kosbel.pl

filip@kosbel.pl

Katalog nie stanowi oferty w rozumieniu prawa i jest publikowany jedynie dla celów informacyjnych. Prowadząc politykę ciągłego rozwoju zastrzegamy sobie prawo do zmian i ulepszeń produktów przedstawionych w katalogu bez uprzedniego powiadomienia. Kolorystyka przedstawiona w katalogu może się różnić od rzeczywistej. Zastrzegamy sobie prawo do błędów w druku.