

Tech-Square

tech.square.allegro@gmail.com

Metal Button Switch Indicator Light

Metal Switch 8~40mm / Indicator Light 6~40mm



Tech-Square



Metal Indicator Light

P 01~04

Ø 6~30mm

Tech-Square
Tech-Square



Metal Button Switch

P 05~07

Ø 12mm



P 08~12

Ø 16mm



P 13~16

Ø 19mm



P 17~20

Ø 22mm



P 21~23

Ø 25mm



P 24

Ø 30mm

Tech-Square
Tech-Square

Tech-Square
Tech-Square

Tech-Square

Metal Indicator Light

Ø 6~30mm

Indicator Light Features

- * Appearance design, beautiful
- * By high-lighting the long life-span LED
- * Internal resistance
- * Ultra short installatio size , installation diameter is complete



Single Lamp

型号说明 Model Instructions

GQL	□	- □	/ □	□	□	□	□
企业代码 Enterprise Code	安装孔尺寸 Size	按键形状 Key type	带灯类型 Lamp type	接线方式 Wiring	带灯颜色 Lamp color	灯珠电压 Lamp voltage	外壳材质 Material
指示灯系列	06 Φ06mm 08 Φ08mm 12 Φ12mm 16 Φ16mm 19 Φ19mm 22 Φ22mm 口径可定制	F 平圆形 B 球形 C 凹形	D 中心单点 E 圆环形灯 T 电源标志 符号可定制	J 插脚 无 螺丝脚	● R 红 ● G 绿 ● Y 黄 ● O 橙 ● B 蓝 ● W 白 ● Red ● Green ● Yellow ● Orange ● Blue ● White	AC/DC 6V 12V 24V 110V 220V 电压可定制 Voltage can be customized	S 不锈钢 N 黄铜镀镍 A 铝合金镀黑 材质可定制
Single lamp	Caliber can be customized	F Flat H High Q Ball TS Emergency stop	D Center point E Ring lamp T Power mark Symbols can be customized	J Pin type Vacancy: Wiring terminal			S Stainless steel N Brass nickel plating A Aluminum alloy black Material can be customized

灯珠规格 Light Ratings

灯珠类型 Lamp Type	额定电压 Rated Voltage	额定电流 Rated Current	发光颜色 Emitting Color	寿命 Life
双向 LED 灯珠 (交直流通用) LED lamp (AC/DC)	AC/DC 6V AC/DC 12V	约 15mA About 15mA	● 红 Red ● 绿 Green ● 黄 Yellow ● 橙 Orange ● 蓝 Blue ● 白 White	40000 小时 (参考值) 40000 hours (Reference)

技术参数 Technology Parameters

灯光电压 LED Voltage	工作电压 Operating Voltage Vop (最小到最大 Min to Max)	额定电流 Rated Current
2VDC (无电阻 No Resistor)	1.8 ~ 2.5 VDC	20mA
12VDC	10.8 ~ 13.2 VDC	20mA
24VDC	21.6 ~ 26.4 VDC	20mA
48VDC	25.2 ~ 30.8 VDC	20mA
110VDC	99 ~ 121 VDC	6mA
230VDC	207 ~ 253 VDC	3mA
灯光颜色 Intensity (Typical) at Iop standard	发光强度 Prominent (所有电压 all voltage)	发光强度 Flush (所有电压 all voltage)
红 Red	7500mcd	2000mcd
绿 Green	4100mcd	250mcd
黄 Yellow	2500mcd	350mcd
蓝 Blue	1300mcd	300mcd
白 White	1900mcd	200mcd

发光强度会降低工作电流

最大电压: 250V

观察角度: 100° (辅助模式)

平均寿命: 40000 小时

工作温度范围: -40°C ~ +85°C

Luminous intensity will be reduced with lower operating current

Max reverse voltage: 250V

Viewing angle: 100° (dependant on mode)

Life expectancy: 40000 hours

Operating temperature range: -40°C ~ +85°C

Single Lamp

金属信号灯 Metal Indicator Light	GQL06F-D	GQL08F-D/J	GQL08F-D/J
安装孔径 Diameter	$\Phi 6\text{mm}$	$\Phi 8\text{mm}$	$\Phi 8\text{mm}$
灯珠类型 Type	LED		
灯珠颜色 Color			
电压等级 Voltage rating	$\leq 220\text{V}$		
额定电流 Rated current	约 15mA About 15mA		
外壳材料 The crust material	不锈钢 Stainless steel / 铜镀镍 Copper nickel plating		
防护等级 Degree	IP68 IK10		
尺寸图 Dimensional Drawing			

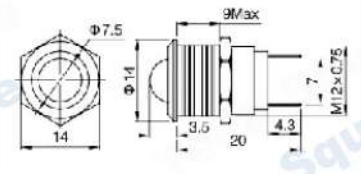
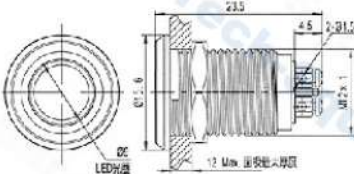
金属信号灯 Metal Indicator Light	GQL10B-D/J	GQL10F-D/J	GQL12F-D
安装孔径 Diameter	$\Phi 10\text{mm}$	$\Phi 10\text{mm}$	$\Phi 12\text{mm}$
灯珠类型 Type	LED		
灯珠颜色 Color			
电压等级 Voltage rating	$\leq 220\text{V}$		
额定电流 Rated current	约 15mA About 15mA		
外壳材料 The crust material	不锈钢 Stainless steel / 铜镀镍 Copper nickel plating		
防护等级 Degree	IP68 IK10		
尺寸图 Dimensional Drawing			

Single Lamp

	GQL16F-D	GQL16F-D/J	GQL19F-D/J
金属信号灯 Metal Indicator Light			
安装孔径 Diameter	Φ 16mm	Φ 16mm	Φ 19mm
灯珠类型 Type	LED		
灯珠颜色 Color			
电压等级 Voltage rating	≤ 220V		
额定电流 Rated current	约 15mA About 15mA		
外壳材料 The crust material	不锈钢 Stainless steel / 铜镍镀 Copper nickel plating		
防护等级 Degree	IP68 IK10		
尺寸图 Dimensional Drawing			

	GQL22F-D	GQL22F-D/J
金属信号灯 Metal Indicator Light		
安装孔径 Diameter	Φ 22mm	Φ 22mm
灯珠类型 Type	LED	
灯珠颜色 Color		
电压等级 Voltage rating	≤ 220V	
额定电流 Rated current	约 15mA About 15mA	
外壳材料 The crust material	不锈钢 Stainless steel / 铜镍镀 Copper nickel plating	
防护等级 Degree	IP68 IK10	
尺寸图 Dimensional Drawing		

Metal Button Switch

Ø 12mm

Metal Switch Features

- * With the stability of the connection performance, the use of security equipment
- * Beautiful, high end, fashion design
- * Medical grade imported stainless steel material, environmental protection is beautiful with no rust
- * Protection performance IP65, waterproof, dust can be competent for the harsh environment
- * Compact design, compact size, can be used for any small equipment

金属按钮特点

- * 具有超稳定的接通性能，保障设备使用安全
- * 美观、高端、时尚的外形设计
- * 医疗级进口不锈钢材质，环保美观永不生锈
- * 防护性能 IP65，防水，防尘适用于恶劣环境
- * 外形尺寸设计紧凑精致，可用于任何小型设备



Φmm12

Metal Button Φ12mm

型号说明 Model Instructions

企业代码 Enterprise Code	安装孔尺寸 Size	按键形状 Key type	开关组合 Switch combination	带灯类型 Lamp type	工作类型 Work type	接线方式 Wiring	带灯颜色 Lamp color	灯珠电压 Lamp voltage	外壳材质 Material
按钮系列 Metal Switch	12 Φ12mm	F 平圆形 H 高平圆形 B 球形 TS 急停 F Flat H High B Bell TS Emergency stop	10 1NO 11 1NO1NC 22 2NO2NC 01 1NC	D 中心单点 E 圆环形灯 T 电源标志 符号可定制 D Center point E Ring lamp T Power mark Symbols can be customized	Z 自锁 无 自复 Z Maintained Vacancy; Mementary	J 插脚 无 螺丝脚 J Pin type Vacancy; Wiring terminal	● R 红 ● G 绿 ● Y 黄 ● O 橙 ● B 蓝 ● W 白 ● Red ● Green ● Yellow ● Orange ● Blue ● White	AC/DC 6V 12V 24V 110V 220V 电压可定制 Voltage can be customized	S 不锈钢 N 黄铜镀镍 A 铝合金镀黑 材质可定制 S Stainless steel N Brass nickel plating A Aluminum alloy black Material can be customized

开关结构说明 Switching Operation

型式 Type	示意图 Diagram	符号 Sign	说明 Explanation
1NO			具有两个端子的双断点慢动触头开关
1NO1NC			具有三个端子的单断点快动转换触头开关
1NO1NC			具有四个端子的双断点快动转换触头开关

灯珠规格 Lamp Ratings

灯珠类型 Lamp type	双向 LED 灯珠 (交直流通用) LED lamp (AC/DC)
额定电压 Rated voltage	3V、6V、12V、24V、36V、110V、220VAC/DC
额定电流 Rated current	约 15mA About 15mA
发光颜色 LED color	R G Y O B W P RG RB
寿命 Life	40000 小时 (参考值) 40000 hours (Reference)

注：如需单向直流 LED 灯珠可定做；其他电压规格可按需求定做
内置电阻：采用 6V 灯珠，需外接电阻。采用交直流通用的 LED 灯珠，
接线端子无正负极区分；60V 以下灯珠已内置保护电阻。

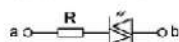

DC LED and other voltage can be made to order.
Using AC/DC LED lamp, the terminals have no difference of anode and cathode: Using inner resistance for the lamp below 60V. Using 6V lamp when the lamp voltage is above 60V, and need connect outer dropping resistance.

Φmm12

Metal Button Φ12mm

金属按钮开关 Metal Push Button Switch	GQ12-B10	GQ12-B10-J	GQ12-F10-J
安装孔径 Diameter	Φ 12mm		
开关额定值 Switch rating	2A / 36VDC		
开关组合 Contact configuration	1NO		
操作类型 Operation type	自复型 Momentary		
外壳材料 The crust material	不锈钢 Stainless steel / 铜镍镀 Copper nickel plating		
防护等级 Degree	IP65 IK08		
尺寸图 Dimensional Drawing			
金属按钮开关 Metal Push Button Switch	GQ12-H10-E/J	GQ12-F10-T/J	GQ12-F10/EZ-J
安装孔径 Diameter	Φ 12mm		
灯珠颜色 Color	R G Y O B W P RE RB		
开关额定值 Switch rating	2A / 36VDC		
开关组合 Contact configuration	1NO		
操作类型 Operation type	自复型 Momentary / 自锁型 Maintained (Z)		
带灯方式 Lamp type	环形带灯 Ring illuminated (LED)	电源标 Power symbol (LED)	环形带灯 Ring illuminated (LED)
外壳材料 The crust material	不锈钢 Stainless steel / 铜镍镀 Copper nickel plating		
防护等级 Degree	IP65 IK08		
尺寸图 Dimensional Drawing			

Metal Button Switch

Ø 16mm

Metal Switch Features

- * With the stability of the connection performance, the use of security equipment
- * Beautiful, high end, fashion design
- * Medical grade imported stainless steel material, environmental protection is beautiful with no rust
- * Protection performance IP65, waterproof, dust can be competent for the harsh environment
- * Compact design, compact size, can be used for any small equipment

金属按钮特点

- * 具有超稳定的接通性能，保障设备使用安全
- * 美观、高端、时尚的外形设计
- * 医疗级进口不锈钢材质，环保美观永不生锈
- * 防护性能 IP65，防水，防尘适用于恶劣环境
- * 外形尺寸设计紧凑精致，可用于各种小型设备



Φmm16

Metal Button Φ16mm

型号说明 Model Instructions

GQ	□	- □	□	/ □	□	- □	□	□	□
企业代码 Enterprise Code	安装孔尺寸 Size	按键形状 Key type	开关组合 Switch combination	带灯类型 Lamp type	工作类型 Work type	接线方式 Wiring	带灯颜色 Lamp color	灯珠电压 Lamp voltage	外壳材质 Material
按钮系列 Metal Switch	16 Φ16mm	F 平圆形 H 高平圆形 B 球形 TS 急停 F Flat H High B Ball TS Emergency stop	10 1NO 11 1NO1NC 22 2NO2NC 01 1NC	D 中心单点 E 圆环形灯 T 电源标志 符号可定制 D Center point E Ring lamp T Power mark Symbols can be customized	Z 自锁 无 自复 Z Maintained Vacancy: Momentary	J 插脚 无 螺丝脚 J Pin type Vacancy: Wiring terminal	● R 红 ● G 绿 ● Y 黄 ● O 橙 ● B 蓝 ● W 白 ● Red ● Green ● Yellow ● Orange ● Blue ● White	AC/DC 6V 12V 24V 110V 220V 电压可定制 Voltage can be customized	S 不锈钢 N 黄铜镀镍 A 铝合金镀黑 材质可定制 S Stainless steel N Brass nickel plating A Aluminum alloy black Material can be customized

开关结构说明 Switching Operation

型式 Type	示意图 Diagram	符号 Sign	说明 Explanation
1NO			具有两个端子的双断点慢动触头开关
1NO1NC			具有三个端子的单断点快动转换触头开关
1NO1NC			具有四个端子的双断点快动转换触头开关

技术参数 Technology Parameters

额定绝缘电压 Rated insulation voltage	250				
发热电流 Heating current Ith	3A 温度不超过最大额定值所允许的电流 Temperature does not exceed the maximum allowed current				
额定使用电压 Rated voltage	12V	24V	110V	220V	
额定使用电流 Rated current	交流 AC 50/60Hz	电阻性负载 Resistive load	-	5A	
		电感性负载 Inductive load	-	3A	
	直流 DC	电感性负载 Inductive load	5A	5A	1A
		电感性负载 Inductive load	2A	2A	0.2A
触点材料 Contact material	铜镀银 Copper plated silver				

最小适应负载: 3V AC/DC 5mA (参考值, 可使用范围取决于使用环境和负载种类)

Minimum load: 3V AC/DC 5mA (Reference value, Use the range depends on the use of the environment and the type of load)

灯珠规格 Lamp Ratings

灯珠类型 Lamp type	双向 LED 灯珠 (交直流通用) LED lamp (AC/DC)
额定电压 Rated voltage	3V、6V、12V、24V、36V、110V、220VAC/DC
额定电流 Rated current	约 15mA About 15mA
发光颜色 LED color	R G Y O B W P RG RB
寿命 Life	40000 小时 (参考值) 40000 hours (Reference)

注: 如需单向直流 LED 灯珠可定做; 其他电压规格可按需求定做
内置电阻; 采用 6V 灯珠, 需外接电阻。采用交直流通用的 LED 灯珠,
接线端子无正负极区分; 60V 以下灯珠已内置保护电阻。

DC LED and other voltage can be made to order.
Using AC/DC LED lamp, the terminals have no difference of anode and cathode; Using inner resistance for the lamp below 60V. Using 6V lamp when the lamp voltage is above 60V, and need connect outer dropping resistance.

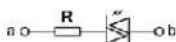

Φmm16

Metal Button Φ16mm

金属按钮开关 Metal Push Button Switch	GQ16-F10-J	GQ16-B10-J	GQ16-H10-J
安装孔径 Diameter	Φ16mm		
开关额定值 Switch rating	2A / 36VAC		
开关组合 Contact configuration	1NO		
操作类型 Operation type	自复型 Momentary		
头部形状 The front shape	平面 Flat	球面 Ball	高头 High
外壳材料 The crust material	不锈钢 Stainless steel / 铜镍镀 Copper nickel plating		
防护等级 Degree	IP65 IK08		
尺寸图 Dimensional Drawing			

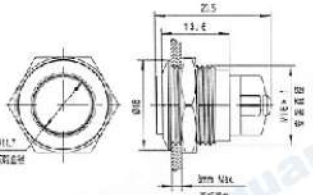
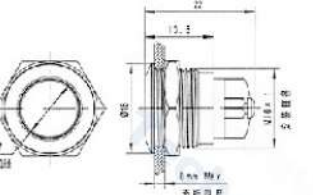
金属按钮开关 Metal Push Button Switch	GQ16-H10	GQ16-F10	GQ16-F11
安装孔径 Diameter	Φ16mm		
开关额定值 Switch rating	2A / 36VAC		3A / 250VAC
开关组合 Contact configuration	1NO		1NO 1NC
操作类型 Operation type	自复型 Momentary		自复型 / 自锁型 Maintained (Z)
头部形状 The front shape	高头 High	平面 Flat	平面 Flat
外壳材料 The crust material	不锈钢 Stainless steel / 铜镍镀 Copper nickel plating		
防护等级 Degree	IP65 IK08		
尺寸图 Dimensional Drawing			

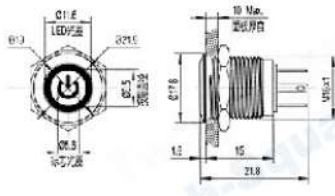
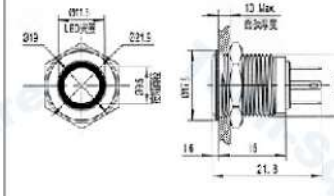
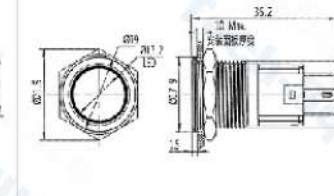
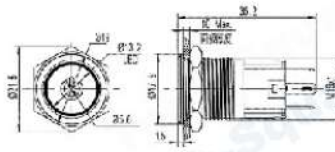
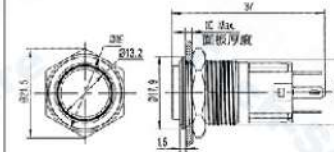
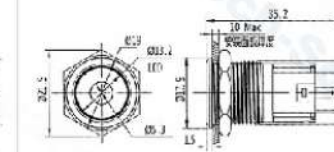

Φmm16

Metal Button Ø16mm

金属按钮开关 Metal Push Button Switch	GQ16-F10-ET/J	GQ16-F10-E/J	GQ16-F11-E/J
安装孔径 Diameter	Φ 16mm		
灯珠颜色 Color	R G Y O B W P RC RB		
开关额定值 Switch rating	2A / 36VAC		3A / 250VAC
开关组合 Contact configuration	1NO		1NO 1NC
操作类型 Operation type	白复型 Momentary		白复型 / 白锁型 Maintained (Z)
头部形状 The front shape	平面 Flat	平面 Flat	平面 Flat
带灯方式 Lamp type	电源标 Pwoer symbol (LED)	环形带灯 Ring illuminated (LED)	环形带灯 Ring illuminated (LED)
外壳材料 The crust material	不锈钢 Stainless steel / 铜镀镍 Copper nickel plating		
防护等级 Degree	IP65 IK10		
尺寸图 Dimensional Drawing			
金属按钮开关 Metal Push Button Switch	GQ16-F11-ET/J	GQ16-H11-E/J	GQ16-F11-D/J
安装孔径 Diameter	Φ 16mm		
灯珠颜色 Color	R G Y O B W P RC RB		
开关额定值 Switch rating	3A / 250VAC		
开关组合 Contact configuration	1NO 1NC		
操作类型 Operation type	白复型 Momentary / 白锁型 Maintained (Z)		
头部形状 The front shape	平面 Flat	高头 High	平面 Flat
带灯方式 Lamp type	电源标 Pwoer symbol (LED)	环形带灯 Ring illuminated (LED)	单点带灯 Dot illuminated (LED)
外壳材料 The crust material	不锈钢 Stainless steel / 铜镀镍 Copper nickel plating		
防护等级 Degree	IP65 IK10		
尺寸图 Dimensional Drawing			

Φmm16

Metal Button Φ16mm

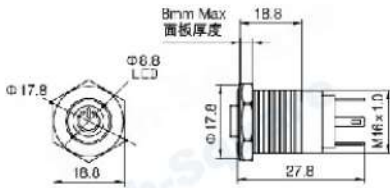
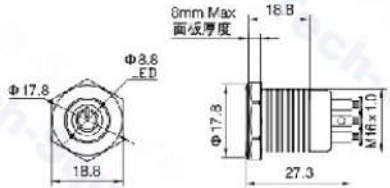
金属按钮开关 Metal Push Button Switch		GQ16-H10-ET/J	GQ16-F10-ET
		 	
安装孔径 Diameter		Φ16mm	
灯珠颜色 Color		R G Y O B W P RG RB	
开关额定值 Switch rating		2A / 36VAC	
开关组合 Contact configuration		1NO	
操作类型 Operation type		自复型 Momentary / 自锁型 Maintained (Z)	
头部形状 The front shape		高头 High	平面 Flat
带灯方式 Lamp type		电源标 Power symbol (LED)	
外壳材料 The crust material		不锈钢 Stainless steel / 铜镀镍 Copper nickel plating	
防护等级 Degree		IP65 IK10	
尺寸图 Dimensional Drawing			

Metal Button Switch

Ø 19mm

Metal Switch Features

- * With the stability of the connection performance, the use of security equipment
- * Beautiful, high end, fashion design
- * Medical grade imported stainless steel material, environmental protection is beautiful with no rust
- * Protection performance IP65, waterproof, dust can be competent for the harsh environment
- * Compact design, compact size, can be used for any small equipment



Φmm19

Metal Button Φ19mm

型号说明 Model Instructions

GQ	□	-□	□	/□	□	-□	□	□	□
企业代码 Enterprise Code	安装孔尺寸 Size	按键形状 Key type	开关组合 Switch combination	带灯类型 Lamp type	工作类型 Work type	接线方式 Wiring	带灯颜色 Lamp color	灯珠电压 Lamp voltage	外壳材质 Material
按钮系列 Metal Switch	19 Φ19mm	F 平圆形 H 高平圆形 B 球形 TS 急停 F Flat H High B Ball TS Emergency stop	10 1NO 11 1NO1NC 22 2NO2NC 01 1NC	D 中心单点 E 圆环形灯 T 电源标志 符号可定制 D Center point E Ring lamp T Power mark Symbols can be customized	Z 自锁 无 自复 Z Maintained Vacancy: Momentary	J 插脚 无 螺丝脚 J Pin type Vacancy: Wiring terminal	● R 红 ● G 绿 ● Y 黄 ● O 橙 ● B 蓝 ● W 白 ● Red ● Green ● Yellow ● Orange ● Blue ● White	AC/DC 6V 12V 24V 110V 220V 电压可定制 Voltage can be customized	S 不锈钢 N 黄铜镀镍 A 铝合金镀黑 材质可定制 S Stainless steel N Brass nickel plating A Aluminum alloy black Material can be customized

开关结构说明 Switching Operation

型式 Type	示意图 Diagram	符号 Sign	说明 Explanation
1NO			具有两个端子的双断点慢动触头开关
1NO1NC			具有三个端子的单断点快动转换触头开关
1NO1NC			具有四个端子的双断点快动转换触头开关

技术参数 Technology Parameters

额定绝缘电压 Rated insulation voltage	250				
发热电流 Heating current Ith	3A 温度不超过最大额定值所允许的电流 Temperature does not exceed the maximum allowed current				
额定使用电压 Rated voltage	12V	24V	110V	220V	
额定使用电流 Rated current	交流 AC 50/60Hz	电阻性负载 Resistive load	-	5A	
		电感性负载 Inductive load	-	3A	
	直流 DC	电感性负载 Inductive load	5A	5A	1A
		电感性负载 Inductive load	2A	2A	0.2A
触点材料 Contact material	铜镀银 Copper plated silver				

最小适应负载: 3V AC/DC 5mA (参考值, 可使用范围取决于使用环境和负载种类)

Minimum load: 3V AC/DC 5mA (Reference value, Use the range depends on the use of the environment and the type of load)

灯珠规格 Lamp Ratings

灯珠类型 Lamp type	双向 LED 灯珠 (交直流通用) LED lamp (AC/DC)
额定电压 Rated voltage	3V、6V、12V、24V、36V、110V、220VAC/DC
额定电流 Rated current	约 15mA About 15mA
发光颜色 LED color	R G Y O B W P RG RB
寿命 Life	40000 小时 (参考值) 40000 hours (Reference)

注: 如需单向直流 LED 灯珠可定做; 其他电压规格可按需求定做
内置电阻; 采用 6V 灯珠, 需外接电阻。采用交直流通用的 LED 灯珠,
接线端子无正负极区分; 60V 以下灯珠已内置保护电阻。

DC LED and other voltage can be made to order.
Using AC/DC LED lamp, the terminals have no difference of anode and cathode: Using inner resistance for the lamp below 60V. Using 6V lamp when the lamp voltage is above 60V, and need connect outer dropping resistance.

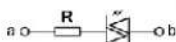

Φmm19

Metal Button Φ19mm

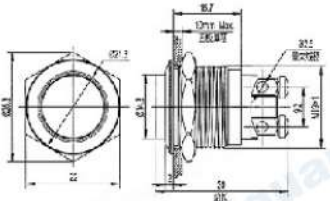
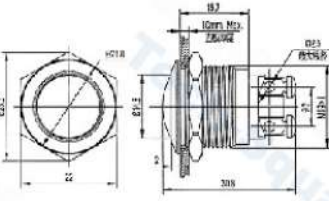
金属按钮开关 Metal Push Button Switch	GQ19-H10	GQ19-F10	GQ19-B10
安装孔径 Diameter	Φ19mm		
开关额定值 Switch rating	2A / 36VDC		
开关组合 Contact configuration	1NO		
操作类型 Operation type	自复型 Momentary		
头部形状 The front shape	高头 High	平面 Flat	球面 Ball
外壳材料 The crust material	不锈钢 Stainless steel / 铜镀镍 Copper nickel plating		
防护等级 Degree	IP65 IK10		
尺寸图 Dimensional Drawing			

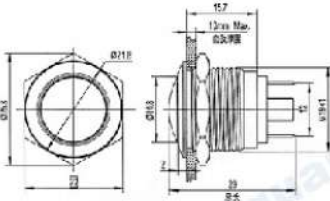
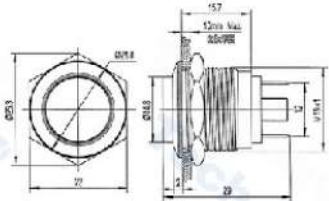
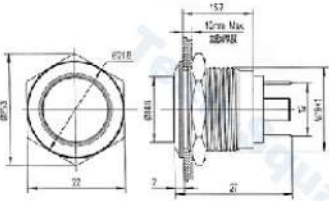
金属按钮开关 Metal Push Button Switch	GQ19-B10-J	GQ19-H10-J	GQ19-F10-J
安装孔径 Diameter	Φ19mm		
开关额定值 Switch rating	2A / 36VDC		
开关组合 Contact configuration	1NO		
操作类型 Operation type	自复型 Momentary		
头部形状 The front shape	球面 Ball	高头 High	平面 Flat
外壳材料 The crust material	不锈钢 Stainless steel / 铜镀镍 Copper nickel plating		
防护等级 Degree	IP65 IK10		
尺寸图 Dimensional Drawing			

Φmm19

Metal Button Φ19mm

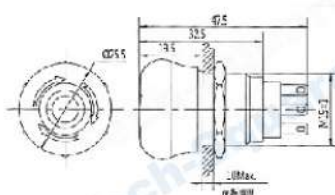
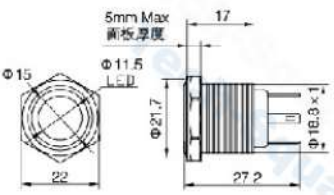
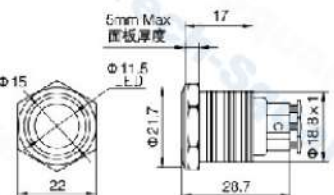
金属按钮开关 Metal Push Button Switch	GQ19-TS11-J	GQ19-F11-E/J	GQ19-F10-E
安装孔径 Diameter	Φ19mm		
灯珠颜色 Color	-	R G Y O B W P R G B	
开关额定值 Switch rating	3A / 250VAC	2A / 36VDC	
开关组合 Contact configuration	1NO 1NC	1NO	
操作类型 Operation type	推锁旋放式 Push-Lock Turn-reset	自复型 Momentary / 自锁型 Maintained (Z)	
头部形状 The front shape	急停 Stop	平面 Flat	
带灯方式 Lamp type	-	环形带灯 Ring illuminated (LED)	
外壳材料 The crust material	不锈钢 Stainless steel / 铜镀镍 Copper nickel plating		
防护等级 Degree	IP65 IK10		
尺寸图 Dimensional Drawing			

金属按钮开关 Metal Push Button Switch	GQ19-F11-ET-J-N	GQ19-H11-E-J-N	GQ19-H11-J-N
安装孔径 Diameter	Φ19mm		
灯珠颜色 Color	R G Y O B W P R G B		-
开关额定值 Switch rating	2A / 36VDC		3A / 250VAC
开关组合 Contact configuration	1NO		1NO 1NC
操作类型 Operation type	自复型 Momentary / 自锁型 Maintained (Z)		
头部形状 The front shape	平面 Flat	高头 High	
带灯方式 Lamp type	电源标 Power symbol(LED)	环形带灯 Ring illuminated (LED)	-
外壳材料 The crust material	不锈钢 Stainless steel / 铜镀镍 Copper nickel plating		
防护等级 Degree	IP65 IK10		
尺寸图 Dimensional Drawing			

Metal Button Switch

Ø 22mm

Metal Switch Features

- * With the stability of the connection performance, the use of security equipment
- * Beautiful, high end, fashion design
- * Medical grade imported stainless steel material, environmental protection is beautiful with no rust
- * Protection performance IP65, waterproof, dust can be competent for the harsh environment
- * Compact design, compact size, can be used for any small equipment

金属按钮特点

- * 具有超稳定的接通性能，保障设备使用安全
- * 美观、高端、时尚的外形设计
- * 医疗级进口不锈钢材质，环保美观永不生锈
- * 防护性能 IP65，防水，防尘适用于恶劣环境
- * 外形尺寸设计紧凑精致，可用于任何小型设备



Φmm22

Metal Button Φ22mm

型号说明 Model Instructions

GQ	□	-□	□	/□	□	-□	□	□	□
企业代码 Enterprise Code	安装孔尺寸 Size	按键形状 Key type	开关组合 Switch combination	带灯类型 Lamp type	工作类型 Work type	接线方式 Wiring	带灯颜色 Lamp color	灯珠电压 Lamp voltage	外壳材质 Material
按钮系列 Metal Switch	22 Φ22mm	F 平圆形 H 高平圆形 B 球形 TS 急停 F Flat H High B Ball TS Emergency stop	10 1NO 11 1NO1NC 22 2NO2NC 01 1NC	D 中心单点 E 圆环形灯 T 电源标志 符号可定制 D Center point E Ring lamp T Power mark Symbols can be customized	Z 自锁 无 自复 Z Maintained Vacancy: Mementary	J 插脚 无 螺丝脚 J Pin type Vacancy: Wring terminal	● R 红 ● G 绿 ● Y 黄 ● O 橙 ● B 蓝 ● W 白 ● Red ● Green ● Yellow ● Orange ● Blue ● White	AC/DC 6V 12V 24V 110V 220V 电压可定制 Voltage can be customized	S 不锈钢 N 黄铜镀镍 A 铝合金镀黑 材质可定制 S Stainless steel N Brass nickel plating A Aluminum alloy black Material can be customized

开关结构说明 Switching Operation

型式 Type	示意图 Diagram	符号 Sign	说明 Explanation
1NO			具有两个端子的双断点慢动触头开关
1NO1NC			具有三个端子的单断点快动转换触头开关
1NO1NC			具有四个端子的双断点快动转换触头开关

技术参数 Technology Parameters

额定绝缘电压 Rated insulation voltage	250				
发热电流 Heating current Ith	3A 温度不超过最大额定值所允许的电流 Temperature does not exceed the maximum allowed current				
额定使用电压 Rated voltage	12V	24V	110V	220V	
额定使用电流 Rated current	交流 AC 50/60Hz	电阻性负载 Resistive load	-	5A	
		电感性负载 Inductive load	-	3A	
	直流 DC	电感性负载 Inductive load	5A	5A	1A
		电感性负载 Inductive load	2A	2A	0.2A
触点材料 Contact material	铜镀银 Copper plated silver				

最小适应负载: 3V AC/DC 5mA (参考值, 可使用范围取决于使用环境和负载种类)

Minimum load: 3V AC/DC 5mA (Reference value, Use the range depends on the use of the environment and the type of load)

灯珠规格 Lamp Ratings

灯珠类型 Lamp type	双向 LED 灯珠 (交直流通用) LED lamp (AC/DC)
额定电压 Rated voltage	3V、6V、12V、24V、36V、110V、220VAC/DC
额定电流 Rated current	约 15mA About 15mA
发光颜色 LED color	R G Y O B W P RG RB
寿命 Life	40000 小时 (参考值) 40000 hours (Reference)

注: 如需单向直流 LED 灯珠可定做; 其他电压规格可按需求定做
内置电阻; 采用 6V 灯珠, 需外接电阻。采用交直流通用的 LED 灯珠,
接线端子无正负极区分; 60V 以下灯珠已内置保护电阻。

DC LED and other voltage can be made to order.
Using AC/DC LED lamp, the terminals have no difference of anode and cathode: Using inner resistance for the lamp below 60V. Using 6V lamp when the lamp voltage is above 60V, and need connect outer dropping resistance.

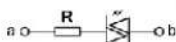

Φmm22

Metal Button Φ22mm

金属按钮开关 Metal Push Button Switch	GQ22B-10	GQ22H-10	GQ22-F10
安装孔径 Diameter	Φ22mm		
开关额定值 Switch rating	2A / 36VDC		3A / 250VAC
开关组合 Contact configuration	1NO		
操作类型 Operation type	自复型 Momentary		
头部形状 The front shape	球面 Ball	高头 High	平面 Flat
外壳材料 The crust material	不锈钢 Stainless steel / 铜镍镀 Copper nickel plating		
防护等级 Degree	IP65 IK08		
尺寸图 Dimensional Drawing			

金属按钮开关 Metal Push Button Switch	GQ22-H10-J	GQ22-H11-E/J
安装孔径 Diameter	Φ22mm	
开关额定值 Switch rating	2A / 36VDC	3A / 250VAC
开关组合 Contact configuration	1NO 1NC	
操作类型 Operation type	自复型 Momentary	自复型 Momentary / 自锁型 Maintained (Z)
头部形状 The front shape	高头 High	高头 High
外壳材料 The crust material	不锈钢 Stainless steel / 铜镍镀 Copper nickel plating	
防护等级 Degree	IP65 IK08	
尺寸图 Dimensional Drawing		

Φmm22

Metal Button Φ22mm

金属按钮开关 Metal Push Button Switch	GQ22-F11-ET-J-S
	
安装孔径 Diameter	Φ22mm
灯珠颜色 Color	R G Y O B W P RG RB
开关额定值 Switch rating	2A / 36VDC
开关组合 Contact configuration	1NO
操作类型 Operation type	自复型 Momentary / 自锁型 Maintained (Z)
头部形状 The front shape	平面 Flat
带灯方式 Lamp type	电源标 Power symbol (LED)
外壳材料 The crust material	不锈钢 Stainless steel / 铜镍镍 Copper nickel plating
防护等级 Degree	IP67 IK08
尺寸图 Dimensional Drawing	

金属按钮开关 Metal Push Button Switch	GQ22-F10-E/J
	
安装孔径 Diameter	Φ22mm
灯珠颜色 Color	R G Y O B W P RG RB
开关额定值 Switch rating	2A / 36VDC
开关组合 Contact configuration	1NO
操作类型 Operation type	自复型 Momentary / 自锁型 Maintained (Z)
头部形状 The front shape	平面 Flat
带灯方式 Lamp type	环形带灯 Ring illuminated (LED)
外壳材料 The crust material	不锈钢 Stainless steel / 铜镍镍 Copper nickel plating
防护等级 Degree	IP67 IK08
尺寸图 Dimensional Drawing	

Metal Button Switch

Ø 25mm

Metal Switch Features

- * With the stability of the connection performance, the use of security equipment
- * Beautiful, high end, fashion design
- * Medical grade imported stainless steel material, environmental protection is beautiful with no rust
- * Protection performance IP65, waterproof, dust can be competent for the harsh environment
- * Compact design, compact size, can be used for any small equipment

* 2022年10月15日 10:00:00



Φmm25

Metal Button Φ25mm

型号说明 Model Instructions

GQ	□	- □	□	/ □	□	- □	□	□	□
企业代码 Enterprise Code	安装孔尺寸 Size	按键形状 Key type	开关组合 Switch combination	带灯类型 Lamp type	工作类型 Work type	接线方式 Wiring	带灯颜色 Lamp color	灯珠电压 Lamp voltage	外壳材质 Material
按钮系列 Metal Switch	25Φ25mm	F 平圆形 H 高平圆形 B 球形 TS 急停 F Flat H High B Ball TS Emergency stop	10 1NO 11 1NO1NC 22 2NO2NC 01 1NC	D 中心单点 E 圆环形灯 T 电源标志 符号可定制 D Center point E Ring lamp T Power mark Symbols can be customized	Z 自锁 无 自复 Z Maintained Vacancy: Mementary	J 插脚 无 螺丝脚 J Pin type Vacancy: Wring terminal	● R 红 ● G 绿 ● Y 黄 ● O 橙 ● B 蓝 ● W 白 ● Red ● Green ● Yellow ● Orange ● Blue ● White	AC/DC 6V 12V 24V 110V 220V 电压可定制 Voltage can be customized	S 不锈钢 N 黄铜镀镍 A 铝合金镀黑 材质可定制 S Stainless steel N Brass nickel plating A Aluminum alloy black Material can be customized

开关结构说明 Switching Operation

型式 Type	示意图 Diagram	符号 Sign	说明 Explanation
1NO			具有两个端子的双断点慢动触头开关
1NO1NC			具有三个端子的单断点快动转换触头开关
1NO1NC			具有四个端子的双断点快动转换触头开关

技术参数 Technology Parameters

额定绝缘电压 Rated insulation voltage	250				
发热电流 Heating current Ith	3A 温度不超过最大额定值所允许的电流 Temperature does not exceed the maximum allowed current				
额定使用电压 Rated voltage	12V	24V	110V	220V	
额定使用电流 Rated current	交流 AC 50/60Hz	电阻性负载 Resistive load	-	5A	
		电感性负载 Inductive load	-	3A	
	直流 DC	电感性负载 Inductive load	5A	5A	1A
		电感性负载 Inductive load	2A	2A	0.2A
触点材料 Contact material	铜镀银 Copper plated silver				

最小适应负载: 3V AC/DC 5mA (参考值, 可使用范围取决于使用环境和负载种类)

Minimum load: 3V AC/DC 5mA (Reference value, Use the range depends on the use of the environment and the type of load)

灯珠规格 Lamp Ratings

灯珠类型 Lamp type	双向 LED 灯珠 (交直流通用) LED lamp (AC/DC)
额定电压 Rated voltage	3V、6V、12V、24V、36V、110V、220VAC/DC
额定电流 Rated current	约 15mA About 15mA
发光颜色 LED color	R G Y O B W P RG RB
寿命 Life	40000 小时 (参考值) 40000 hours (Reference)

注: 如需单向直流 LED 灯珠可定做; 其他电压规格可按需求定做
内置电阻; 采用 6V 灯珠, 需外接电阻。采用交直流通用的 LED 灯珠,
接线端子无正负极区分; 60V 以下灯珠已内置保护电阻。

DC LED and other voltage can be made to order.
Using AC/DC LED lamp, the terminals have no difference of anode and cathode: Using inner resistance for the lamp below 60V. Using 6V lamp when the lamp voltage is above 60V, and need connect outer dropping resistance.

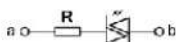

Φmm25

Metal Button Φ25mm

金属按钮开关 Metal Push Button Switch	GQ25-H10-J	GQ25-F10-J
安装孔径 Diameter	Φ25mm	
开关额定值 Switch rating	2A / 36VDC	
开关组合 Contact configuration	1NO	
操作类型 Operation type	自复型 Momentary / 自锁型 Maintained (Z)	
头部形状 The front shape	高头 High	平面 Flat
外壳材料 The crust material	不锈钢 Stainless steel / 铜镍镍 Copper nickel plating	
防护等级 Degree	IP67 IK10	
尺寸图 Dimensional Drawing		

金属按钮开关 Metal Push Button Switch	GQ25-F11-E-J-S	
安装孔径 Diameter	Φ25mm	
灯珠颜色 Color	R G Y C B W R R	
开关额定值 Switch rating	2A / 36VDC	
开关组合 Contact configuration	1NO	
操作类型 Operation type	自复型 Momentary / 自锁型 Maintained (Z)	
头部形状 The front shape	平面 Flat	
带灯方式 Lamp type	环形带灯 Ring illuminated (LED)	
外壳材料 The crust material	不锈钢 Stainless steel / 铜镍镍 Copper nickel plating	
防护等级 Degree	IP67 IK10	
尺寸图 Dimensional Drawing		

Φmm30

Metal Button Φ30mm

金属按钮开关

Metal Push Button
Switch

GQ30-F22-J-S



安装孔径 Diameter	Φ30mm
开关额定值 Switch rating	3A / 250VAC
开关组合 Contact configuration	1NO 1NC
操作类型 Operation type	自复型 Momentary / 自锁型 Maintained (Z)
头部形状 The front shape	平头 Flat
外壳材料 The crust material	不锈钢 Stainless steel / 铜镀镍 Copper nickel plating
防护等级 Degree	IP67 IK10

尺寸图 Dimensional Drawing

